

STAINO & STAINO

Doors & Furnishing's systems



COLLECTION

Sliding doors

The 'Collection Sliding Doors' catalogue is dedicated to our sliding system proposals. The product range is divided into the Easy-S, Extra Light, Master, Segreta and Glass collections. The completeness of the range and the exclusivity of the customizations available are the result of decades of work, design, production and constant commitment to refining our products.

To guarantee the best possible quality, we carry out the entire production cycle within our factory: production, assembly and quality control. For some specific components, we collaborate with other leading companies in the relevant sector, exclusively Italian, controlled and selected with the highest quality standards.

All STAINO&STAINO products are truly Made in Italy.



Easy-S Collection 06

Crosspieces 26

Portfolio 28
our customers's photos



Extra Light Collection 30

Fixed all-glass doors 42

Crosspieces 46

Portfolio 48
our customers's photos



Master Collection 50

Portfolio 56
our customers's photos



Glass Collection 58

Portfolio 64
our customers's photos



Segreta-S sliding coplanar door 66

Portfolio 72
our customers's photos



Versus Closets 74

Portfolio 80
our customers's photos

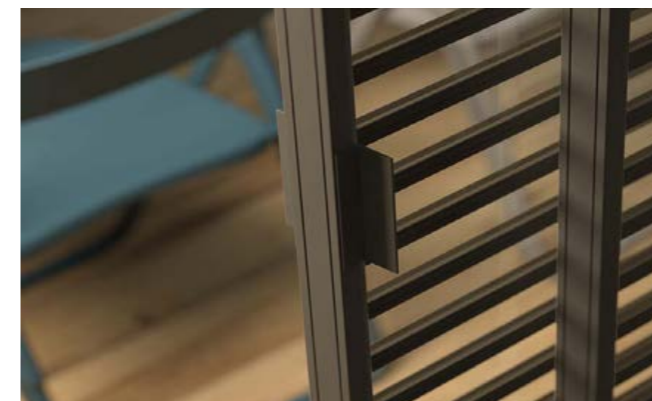

Dedicated handles 82
our customers's photos

MAGIC OPENING SYSTEM 90

DATA SHEET opening typologies 94

DATA SHEET doors 96

FINISHINGS & DECORATIONS 110

Collection Easy-S

The **Easy-S** sliding panel system allows the division of internal spaces with doors characterized by a particularly thin perimeter profile, in line with the most rigorous and contemporary architectural projects.

The design of **Easy-S** was developed around two primary needs: the reduced section of the profile, which amplifies the feeling of openness of the spaces and responds to the aesthetic needs of the designers, and the commercial competitiveness, obtained thanks to particularly rapid manufacturing.

The **Easy-S** sliding doors can be coordinated with the pivoting version.

As with the other company collections, the **Easy-S** system can also be customized in terms of profile and glass finishes.

Easy-S 4-panel sliding door | matt black profile PA03 | transparent glass CR01 | crosspieces Three | handles MA17



Easy-S 4-panel sliding door | matt black profile PA03 | transparent glass CR01 | crosspieces Three | handles MA17



Easy-S 4-panel sliding door | matt black profile PA03 | transparent glass CR01 | crosspieces Three | handles MA17



SLIDING EASY-S

*with built-in guides or
guide with valance*

The Easy-S door is **tailor-made to the millimetre**, both in height and width.

The customer can choose from a wide range of finishes for both the profile and the glass. The sliding tracks can be classic or recessed (as in the photo).

It is possible to communicate with our technicians to evaluate all design opportunities and create the solution that best suits the customer's needs.



Built-in guide
recordable

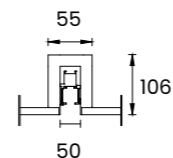

Guides with
valance

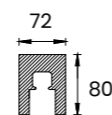

Easy-S sliding door | matt white profile PA02 | smoked transparent glass CR05 | handle MA17



Easy-S 2-panel sliding door | matt white profile PA02 | milky white glass CR03 | handle MA17

LAMINATED GLASS

milky white

The **milky white opaline glass** guarantees privacy without preventing the diffusion of light.

Particularly simple to clean, it has both shiny sides, as the opal surface remains inside the two sheets joined by the stratification process which guarantees maximum safety.

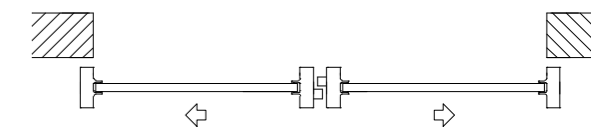

Guides with
valance

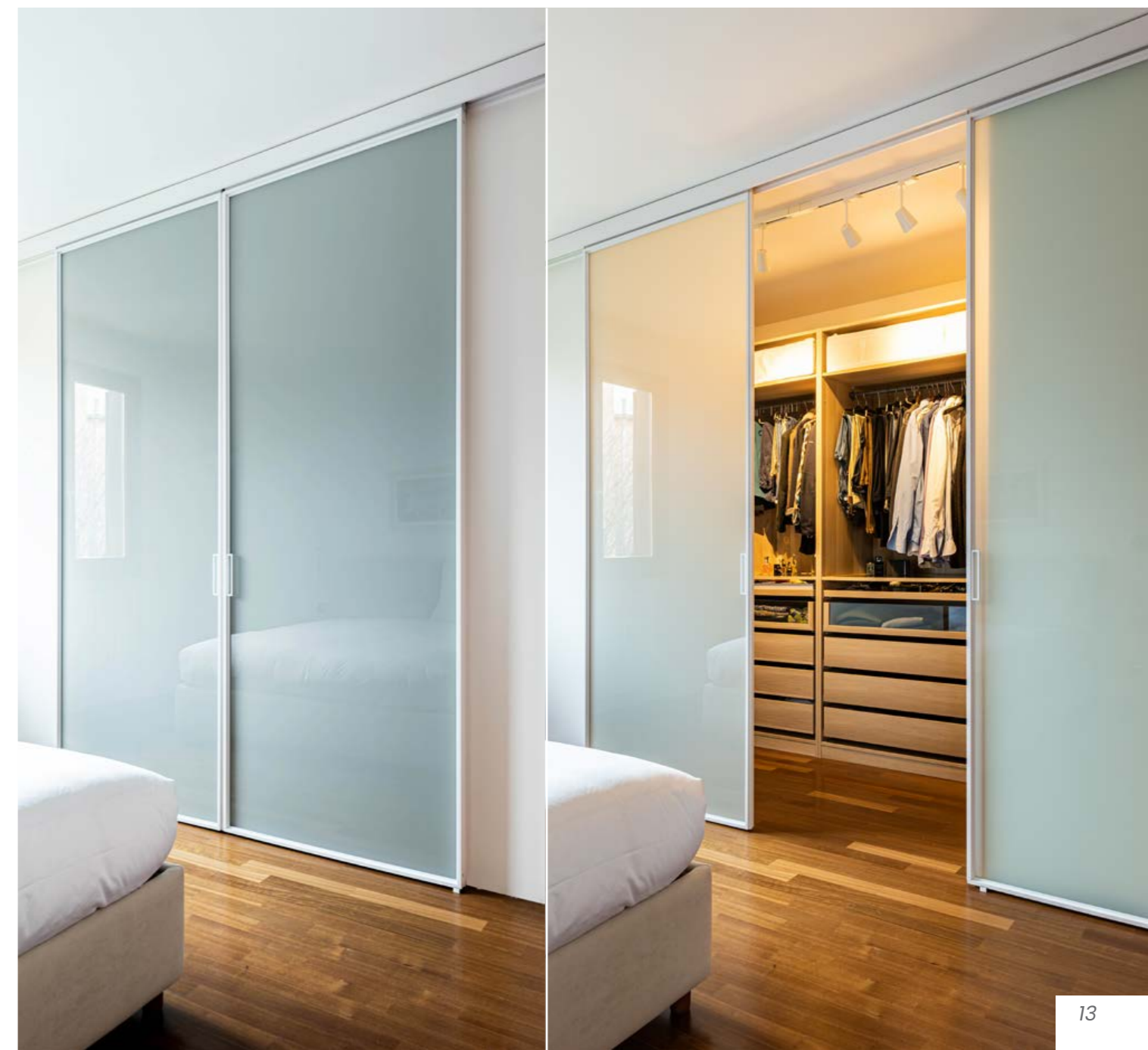
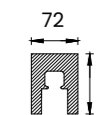

SMOKED REFLECTIVE GLASS

the level of transparency varies in relation to the light present

Photos 1 and 2 - when the glass is illuminated only from the outside the surface appears reflective/mirrored.

Photos 3 and 4 - vice versa, when light is present on the opposite side, the door changes appearance, becoming almost completely transparent.

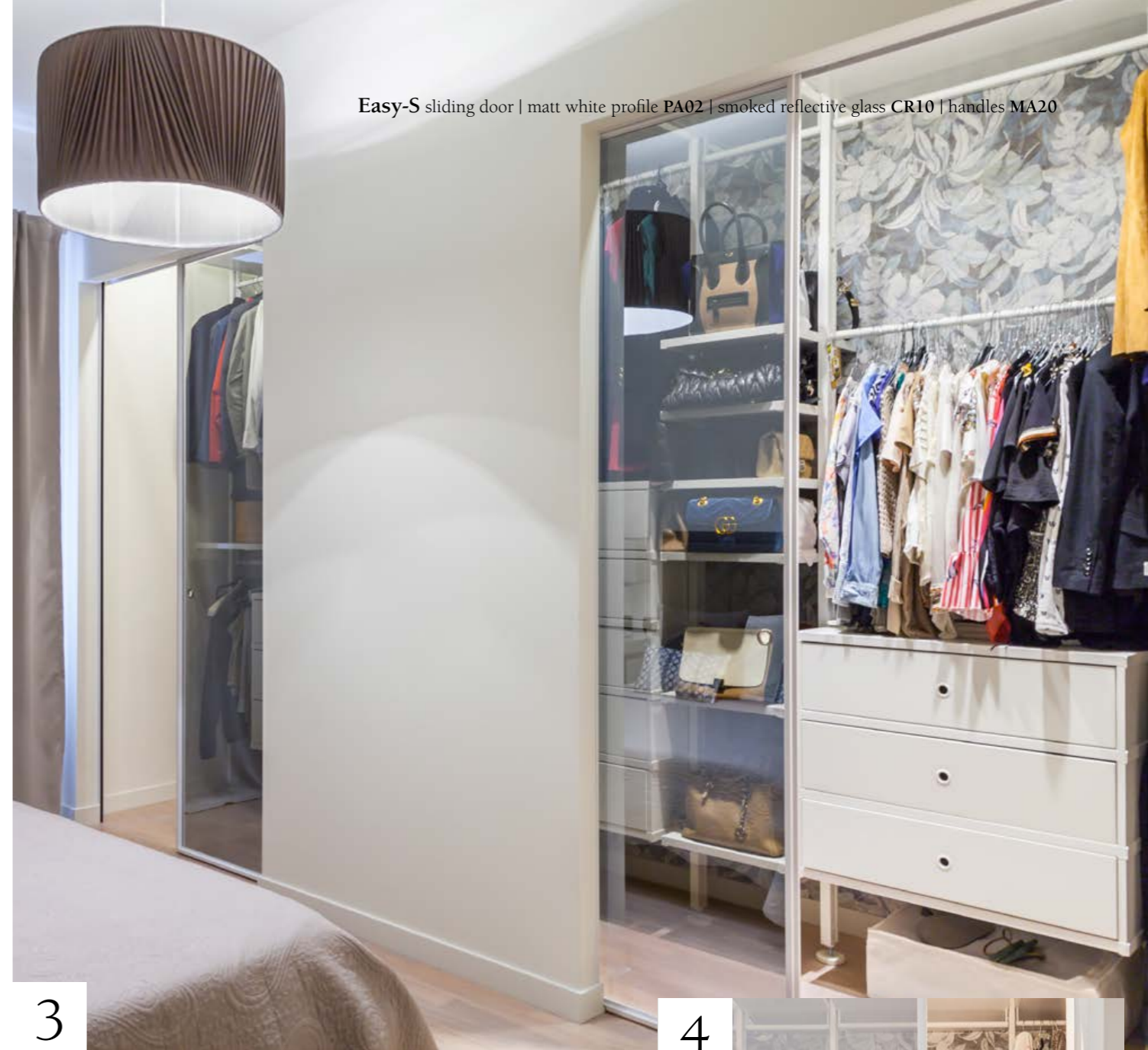

Easy-S sliding door | matt white profile PA02 | smoked reflective glass CR10 | handles MA20

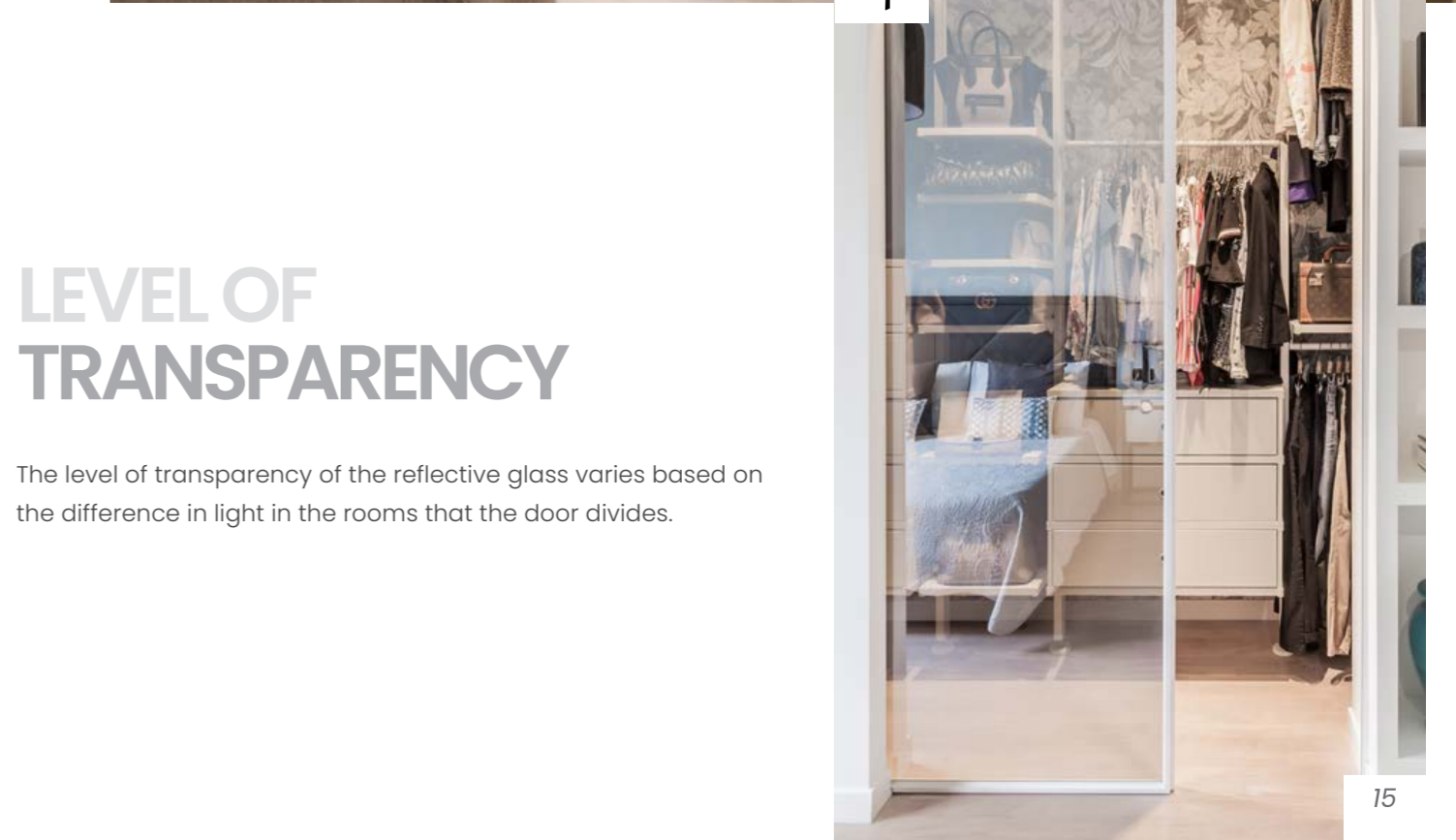

LEVEL OF TRANSPARENCY

The level of transparency of the reflective glass varies based on the difference in light in the rooms that the door divides.

Easy-S sliding door | matt white profile PA02 | smoked reflective glass CR10 | handles MA20



DOOR SLAM POST

optional

10x10 mm profile
added to the door

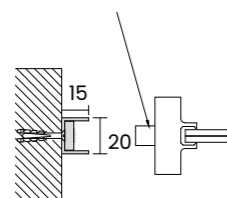

In the photo, the Easy-S sliding door with transparent glass and profile in PA13 sanded iron gray finish.

The **optional wall-mounted jambs** provide a better seal between the door and the brickwork even in the presence of skirting boards.



Easy-S 2-panel sliding door | sandblasted iron grey profile PA13 | transparent glass CR01 | crosspieces Three | handles MA17



Easy-S 2-sliding + 2 fixed doors | matt black profile PA03 | transparent glass CR01 | crosspieces custom h20mm | handles MA17

FIXED&OPENABLE SYSTEM

and telescopic brush

The Easy-S sliding door can be combined with Easy-S fixed doors.

The creation of the doors is always tailored to the millimetre, optional handles with integrated lock or the standard MA 17 handle without lock are available as in the photo below.

Optional profiles reduce the gap between the door and the side walls.

The profile finish is coordinated with that of the door.

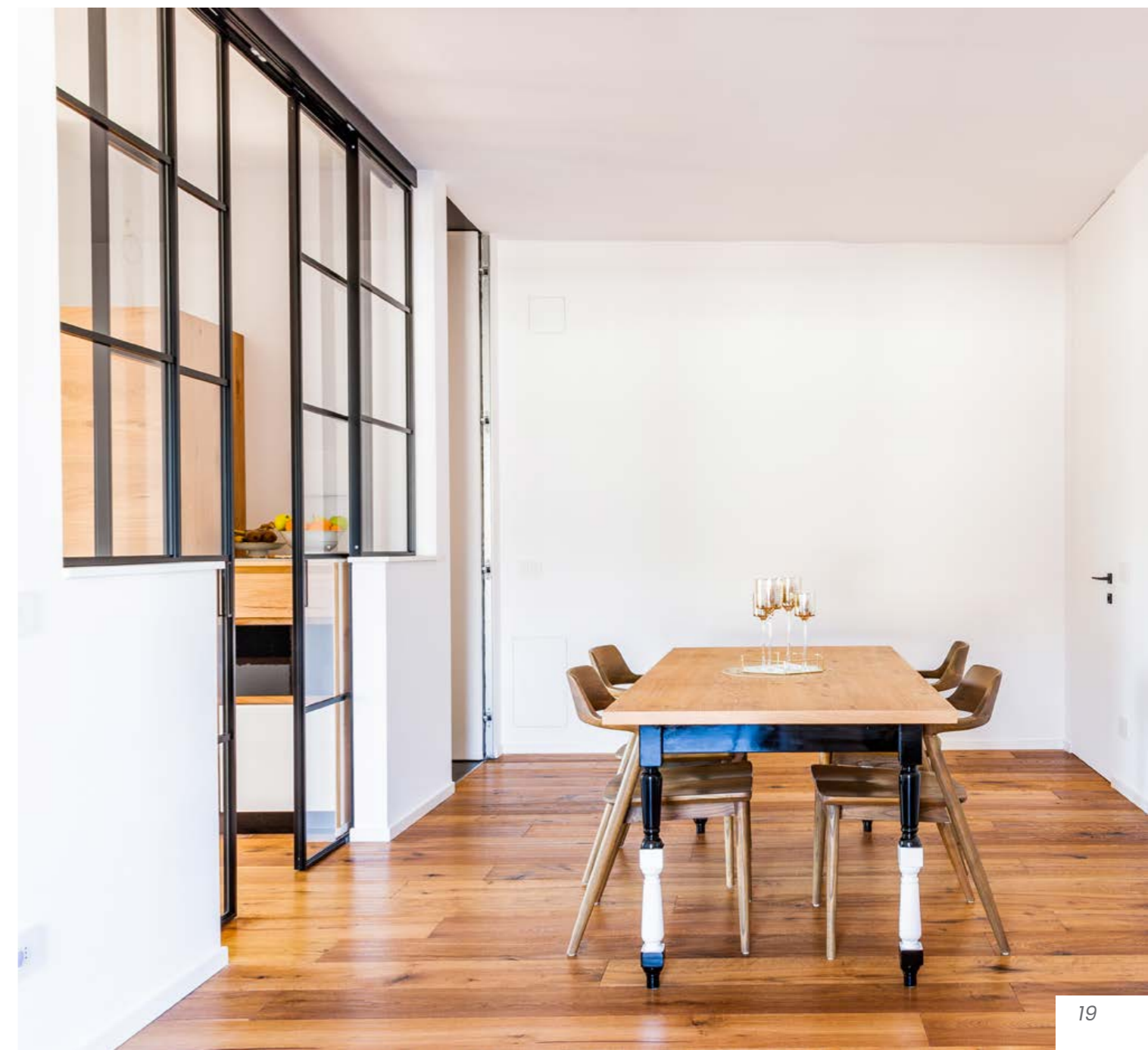

OVERLAYABLE DOORS

*with drag
system*

This optional sliding version allows the doors to overlap on one side only, in this way the passage size is exploited to the maximum.



Easy-S 3-panel sliding door | matt black profile PA03 | smoked transparent glass CR05 | handle MA17

Easy-S 3-panel sliding door | matt black profile PA03 | smoked transparent glass CR05 | handle MA17



Easy-S 3-panel sliding door | bronze profile PA05 | double bronze reflective glass with internal satin finish CR11 | handle MA17

Master flush-to-the-wall door | bronze profil PA05 | bronze mirror SP02 + bronze mirror SP02 boiserie | handle MA15

Boiserie Easy-S & Master

In this project, designed by the architect Francesco Donnalioia of Space Studio (www.spacestudio.it), a particular creation is visible that combines the **sliding doors of the Easy-S collection** with a boiserie coordinated with the flush-to-the-wall door of the Master collection.





Easy-S 3-panel sliding door | bronze profile PA05 | double bronze reflective glass with internal satin finish CR11 | handle MA17



Easy-S scorrevole a 3 ante | profilo bronzo PA05 | doppio vetro riflettente bronzo con satinatura interna | maniglia MA17
Master battente | profilo bronzo PA05 | specchio bronzo SP02 + boiserie specchio bronzo SP02 | maniglia MA15

DOUBLE RIFLECTIVE GLASS

with internal satin finish

In these images, you can see the double reflective glass with layered satin finish inside the two panes, in this way you can combine the privacy of the satin glass with the aesthetic effect of the reflective crystals that maintain the ability to diffuse the light.



Crosspieces

To enrich the aesthetics of Easy-S, crosspieces made of extruded aluminum are available on request, applied on both sides of the glass.

The crosspieces dedicated to the Easy-S collection have a section of 12 x 12 mm horizontally and 10 x 10 mm vertically, they are positioned on both sides of the glass. The finish of the crosspieces is coordinated with the perimeter profiles of the door. Crossbars are not available for mirror doors.

For any customized compositions, ask for feasibility and prices at: commerciale@stainoestaino.it



PORTFOLIO

*You can see photos of some of our creations
by framing the QR codes*



Easy-S panel sliding door + 2 fixed panels | matt black profile PA03 | transparent glass CR01 | crosspieces Three | handles MA17

Design Apartment

A large Easy-S sliding door with a special height of 360 cm in this project designed by the architects Mariella Corsi and Laura Bianchi of ARCHBCSTUDIO (www.archbcstudio.com)

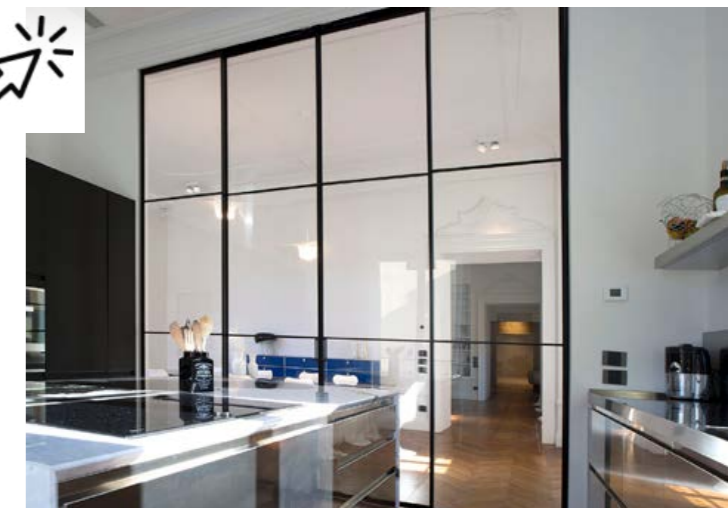

Identity Project

Easy-s sliding doors with crosspieces arranged based on a design by architects Lorenzo Cantini and Valentina Michelacci of Identity Design (www.identitydesign-group.com).



City Home

Numerous doors from the Staino&Staino Easy-S and Revolution® collections were included in the renovation of an important city villa.



Habitat Project

Easy-S door with four sliding doors with matt black extruded aluminum profile and transparent glass. MA 17 handle, with finish coordinated with the profile. Door created for Habitat Immobiliare, Prato.



Collection Extra Light

Extra Light is one of the most representative collections of STAINO&STAINO, with a frontal dimension of the perimeter profile of just 25 mm, it maintains the possibility of building very large doors (L 150 x 300 cm in H).

The result is a **minimal sliding door** in which the perimeter frame leaves the glass as the protagonist. The Extra Light sliding doors can be coordinated with the swing versions, which can also be made at full height, to maintain aesthetic continuity even in the case of different door types in the same environment.

The formal cleanliness of the **Extra Light** doors can be enriched thanks to the special versions with **crosspieces**, in the 40.20, 20.20, Factory and Wall models.

The 10 or 20 mm crosspieces can also be positioned according to the customer's design.

Extra Light 2-panel sliding door | corten profile and valance PA09 | transparent glass CR01 | crosspieces 40.20 | handles MA09



Extra Light 2-panel sliding door | corten profile and valance PA09 | transparent glass CR01 | crosspieces 40.20 | handles MA09

EXTRA LIGHT 40.20

The Extra Light door in the **40.20** scheme is characterized by 20 mm crosspieces arranged on the glass every 40 mm.

The customer can choose both the profile finish and the glass finish, while the sliding system can be of the classic type with covering valance or recessed.

For customized compositions, ask for feasibility at: commerciale@stainoestaino.it

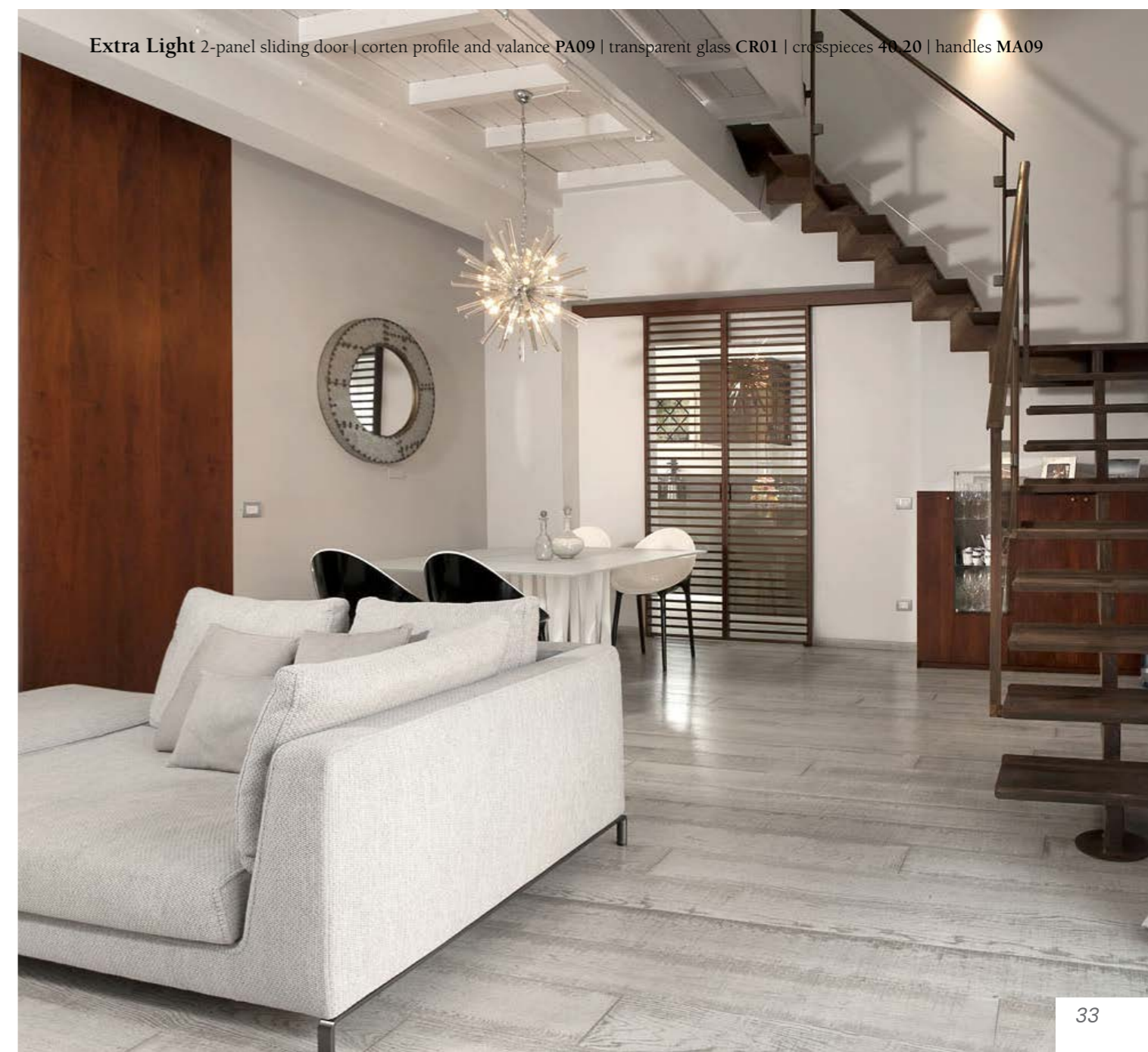
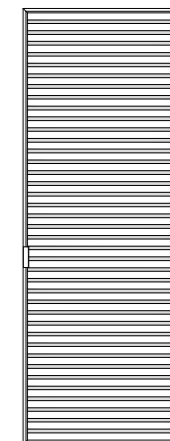

Extra Light 2-panel sliding door | corten profile and valance PA09 | transparent glass CR01 | crosspieces 40.20 | handles MA09



Extra Light 3-panel sliding door | corten profile PA09 | transparent glass CR01 | crosspieces 20.20 | handles MA09

EXTRA LIGHT 20.20

*transparency
effect*

The **20.20** scheme of the Extra Light door is characterized by the reduced spacing between the glass and the 20 mm aluminum crosspieces.

For customized compositions, ask for feasibility at:

commerciale@stainoestaino.it

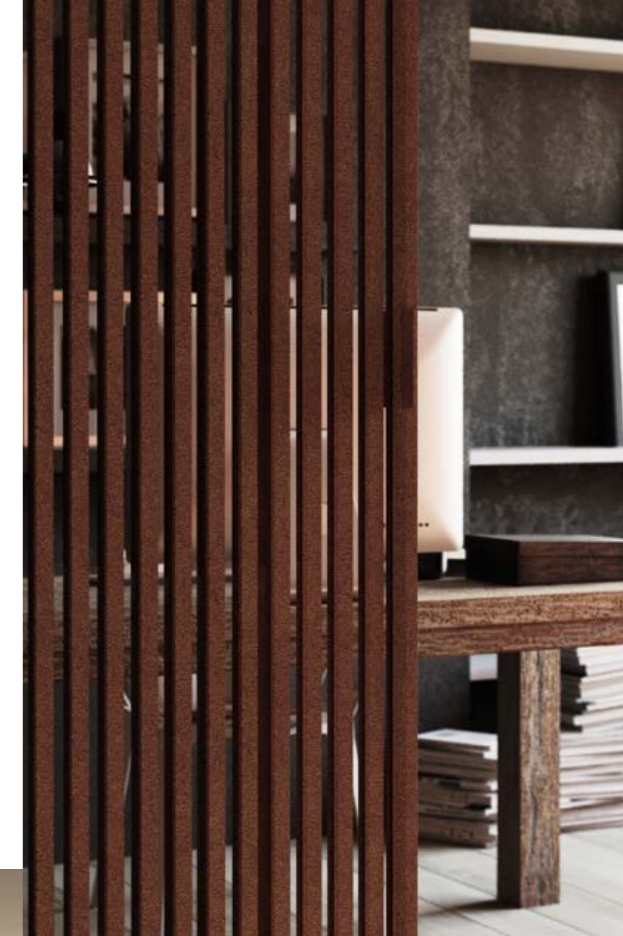
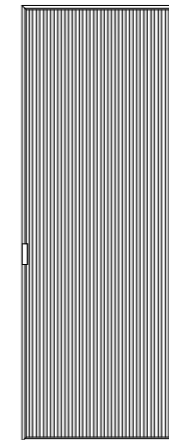

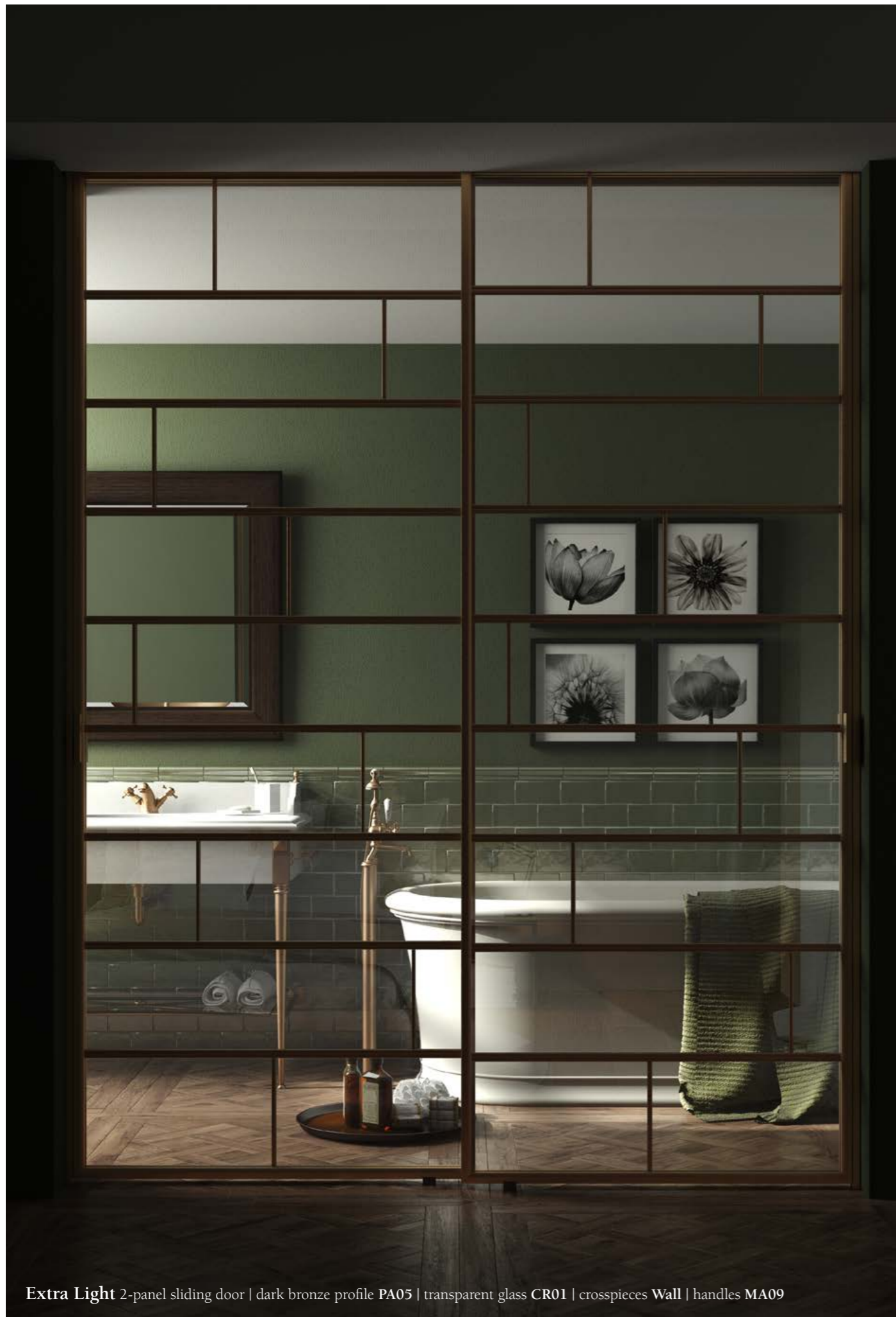

Extra Light 2-panel sliding door | dark bronze profile PA05 | transparent glass CR01 | crosspieces Wall | handles MA09

EXTRA LIGHT WALL

Extra Light with the **Wall scheme** with 20 mm horizontal and 10 mm vertical crosspieces.

The result is a brick-effect composition proportionate to the size of the door.

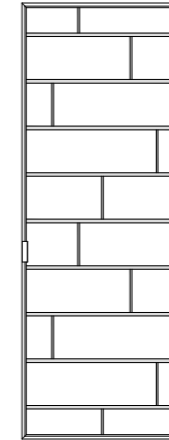

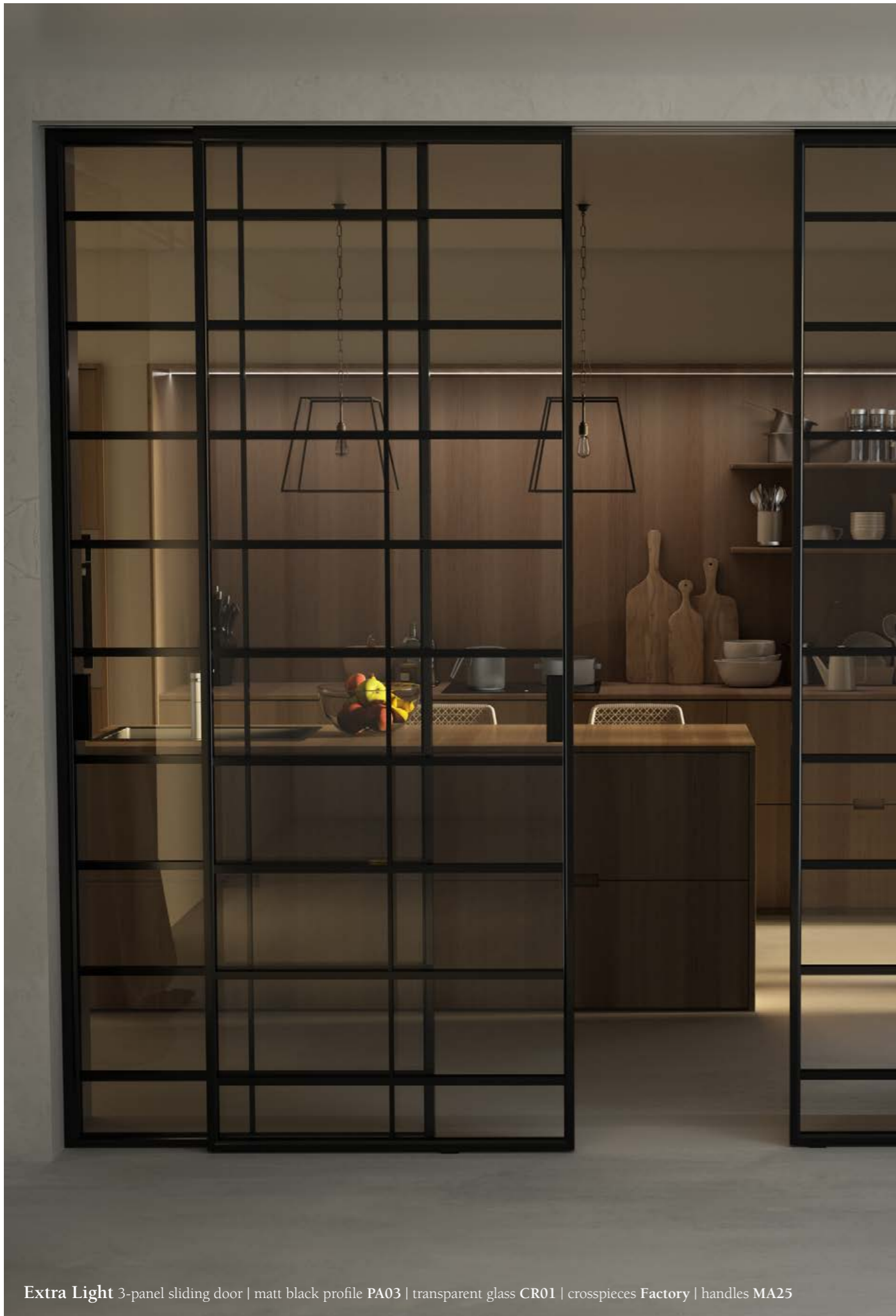

Extra Light 3-panel sliding door | matt black profile PA03 | transparent glass CR01 | crosspieces Factory | handles MA25

EXTRA LIGHT FACTORY

In the **Factory** scheme the 20 mm horizontal crosspieces are spaced 240 mm apart; the vertical ones are 10 mm.

Depending on the width, the door is equipped with one or two vertical crosspieces.

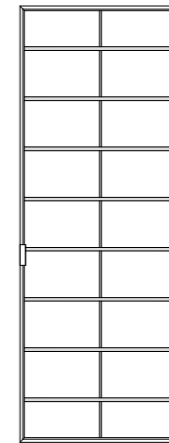



EXTRA LIGHT INTERNAL WALL

two-panels sliding door

The Extra Light sliding door inside the wall can be set up for insertion in classic or flush-to-the-wall sliding boxes of any brand.

The door can be equipped with an extruded aluminum frame and architraves. The aluminum architraves are available in a wide range of finishes or can be made in a matt color as per sample.

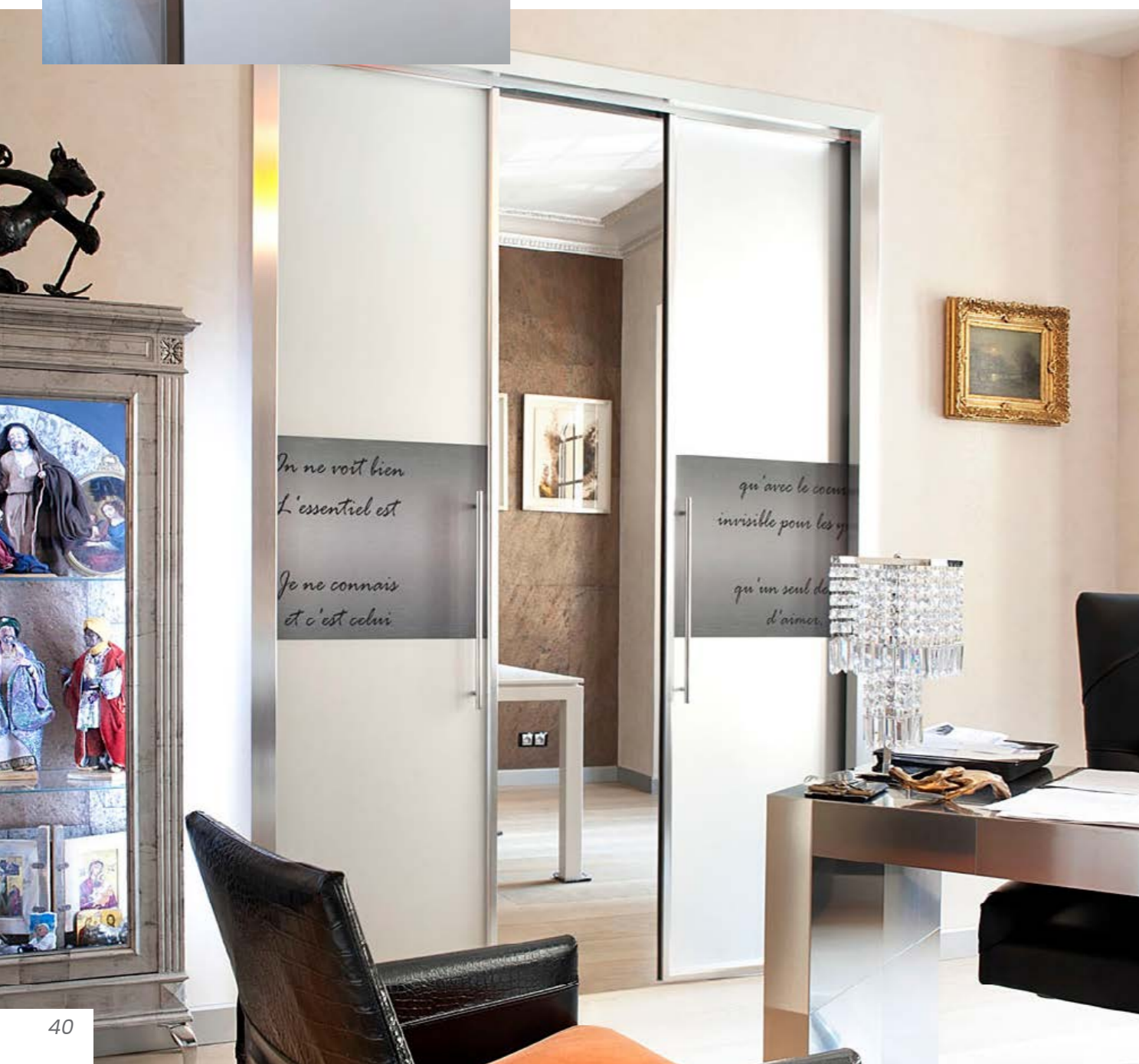

Extra Light 2-panels sliding door | profile and casing **custom finishing** | extra-clear satin glass CR07 with custom decorations | handle MA05

Fixed all-glass doors + ExtraLight

Fixed all-glass panels + Extra Light sliding doors.

In combination with the Extra Light sliding panels, entirely glass doors are available with fixing profiles positioned only on the floor and ceiling.

The profiles for fixing the fixed doors have a reduced section and can be made with a finish coordinated with the Extra Light profiles.

Extra Light 20.20 2-panels sliding door | dark bronze profile PA11 | transparent profile CR01 | crosspieces 20.20 | handles MA27



Extra Light20.20 2-panels sliding door | dark bronze profile PA11 | transparent profile CR01 | crosspieces 20.20 | handles MA27

TRANSPARENT ELEGANCE

Particularly light is the coupling of the glass doors with a polished edge, accompanied by joint profiles in transparent polycarbonate.

The fixing profiles for the all-glass doors are available in all the finishes foreseen for the Extra Light doors.



Crosspieces

To enrich the aesthetics of Extra Light, crosspieces made of extruded aluminum are available on request, applied on both sides of the glass.

The crosspieces dedicated to the Extra Light collection have a section of 20 x 10 mm horizontally and 10 x 8 mm vertically, they are positioned on both sides of the glass. The finish of the crosspieces is coordinated with the perimeter profiles of the door. Crossbars are not available for mirror doors.

For any customized compositions, ask for feasibility and prices at: commerciale@stainoestaino.it



Without crosspieces



20 mm horizontal crosspieces spaced 40 mm apart.

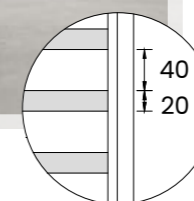

20 mm horizontal crosspieces spaced 80 mm apart.

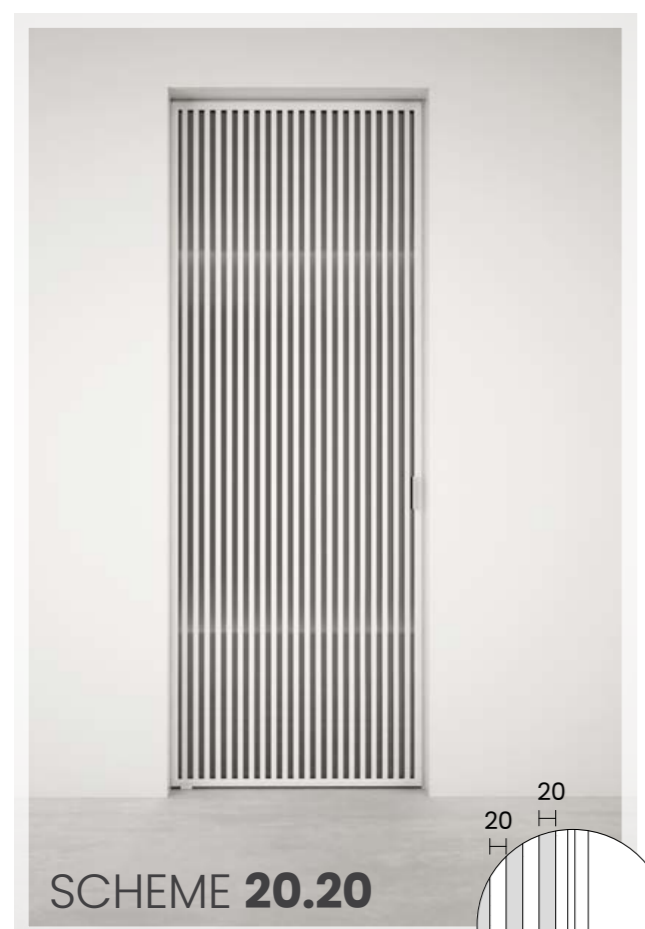
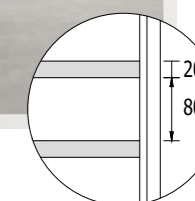

20 mm vertical crosspieces spaced 20 mm apart.

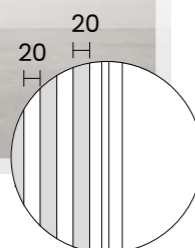

20 mm vertical crosspieces spaced 40 mm apart.

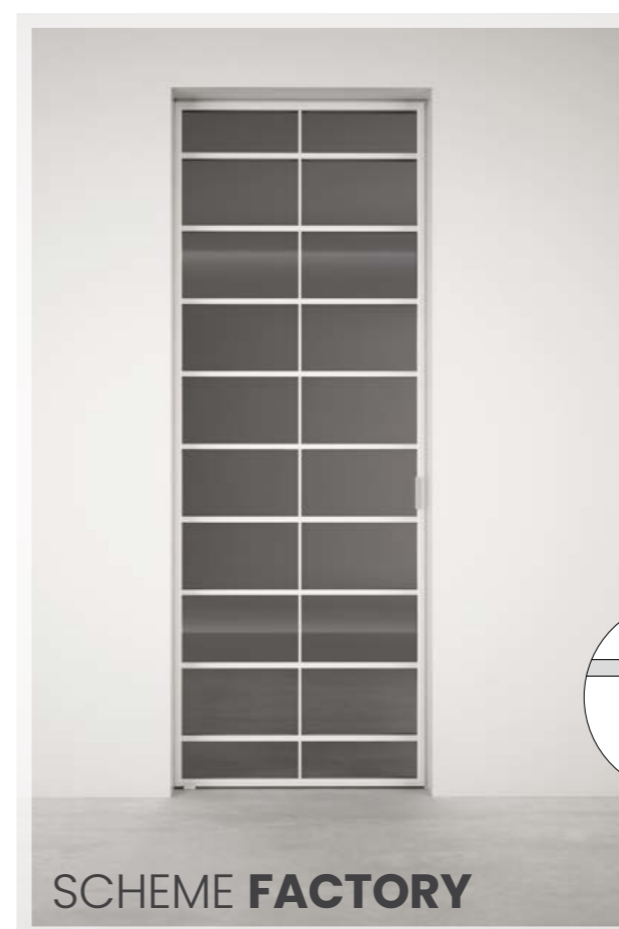
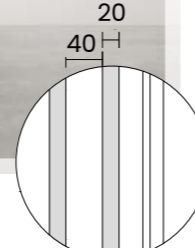

20 mm horizontal crosspieces spaced 240 mm apart. 10 mm horizontal crosspieces. The positioning of the crosspieces is adapted based on the size of the door ordered.

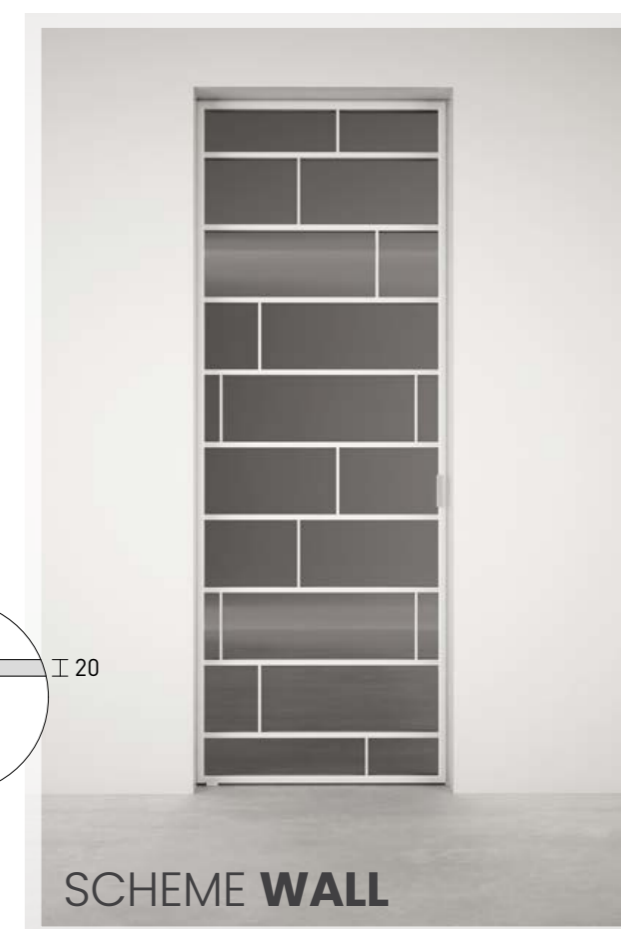
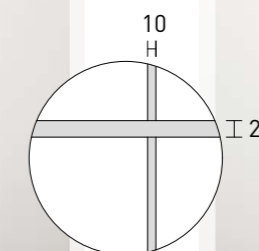

In both models, the first and last horizontal crosspieces are positioned to measure based on the height of the door.

PORTFOLIO

*You can see photos of some of our creations
by framing the QR codes*



Extra Light 2-panel sliding door | corten profile and valance PA09 | transparent glass CR01 | crosspieces 40.20 | handles MA09

Extra Light Loft

The Extra Light door in the 40.20 version is the protagonist of a project signed by designer Jacopo Cecchi.

www.jacopocecchi.com



Home Office

A project in the heart of Nice where Extra Light and Master doors were chosen for an elegant workspace.



Tuscany Home

The project of this villa involved the use of many Staino&Staino doors including Extra Light made with extra-clear sandblasted glass with DS decoration.



Data sheet

You can download the technical sheet dedicated to the Extra Light Collection from our website www.stainoestaino.it.



CATALOGUE

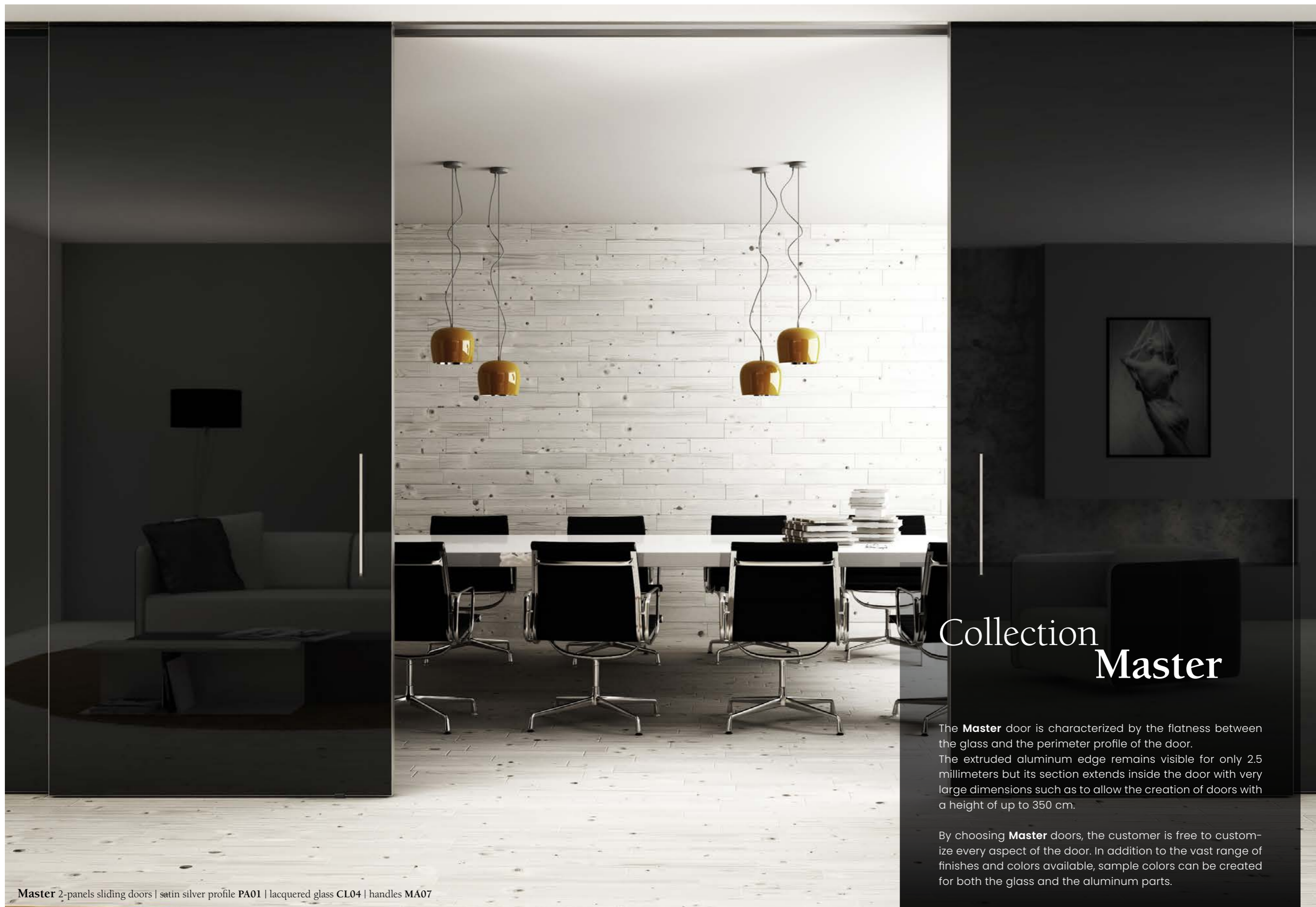

Master 2-panels sliding doors | satin silver profile PA01 | lacquered glass CL04 | handles MA07

Collection Master

The **Master** door is characterized by the flatness between the glass and the perimeter profile of the door. The extruded aluminum edge remains visible for only 2.5 millimeters but its section extends inside the door with very large dimensions such as to allow the creation of doors with a height of up to 350 cm.

By choosing **Master** doors, the customer is free to customize every aspect of the door. In addition to the vast range of finishes and colors available, sample colors can be created for both the glass and the aluminum parts.

SLIDING MASTER DOOR

flush-fitting cassette system

The **Master sliding door inside the wall** can be set up for insertion in sliding cassette system that do not require the assembly of casings. Upon customer request, the company can supply both the door and the sliding subframe.

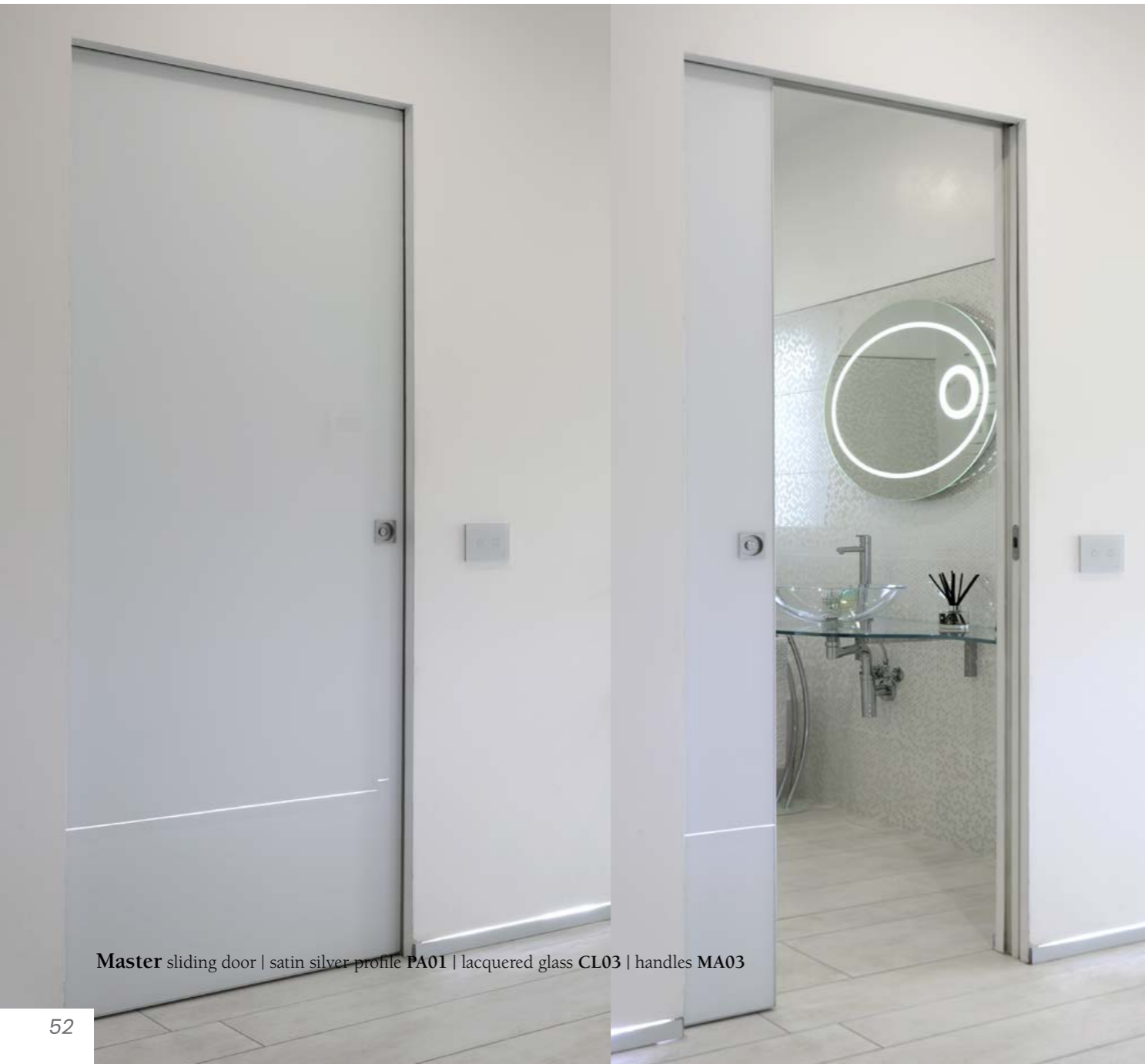
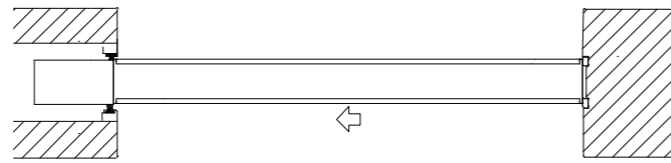

Master sliding door | satin silver profile PA01 | lacquered glass CL03 | handles MA03

Master sliding door | satin silver profile PA01 | lacquered metropoli mirror CL09 | handles MA03



SLIDING MASTER DOOR

classic pocket cassette system

The Master internal wall sliding door can be set up for insertion into **classic sliding cassettes** of any brand, in this case the door is equipped with an **extruded aluminum frame and casing**.

The aluminum casing is available in a wide range of finishes, including matt sample colours.





Master sliding door | satin silver profile PA01 | glass with DV13 decoration | handles MA03



SLIDING MASTER DOOR

outside the wall

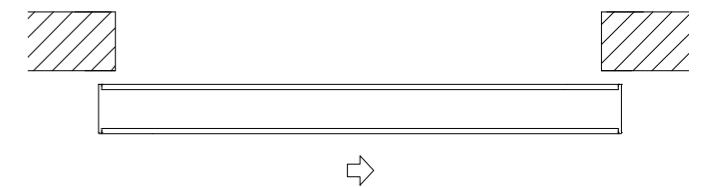

The external wall sliding Master door **is always made to measure** without feasibility limits.

The finish may be different between one side of the door and the other; among the wide range of glass available there are glasses decorated with DV photographic print which can be personalized with images and drawings upon customer request.

PORTFOLIO

*You can see photos of some of our creations
by framing the QR codes*



Master sliding door | satin silver profile PA01 | glass with DV13 decoration | handles MA03

Black & Blue

Doors from the Master, Glass and Versus collections in a prestigious project with customized finishes.



Tuscany Home

A project in the heart of Nice where Extra Light and Master doors were chosen for an elegant workspace.



White Flat

Flush-to-the-wall internal doors from the Master collection with lacquered glass, combined with a recessed skirting board created specifically for this project.



Data sheet

You can download the technical sheet dedicated to the Master Collection from our website www.stainoe-staino.it.



CATALOGUE

Collection Glass

Glass is a system designed to create completely glass doors. The Glass sliding doors can also be coordinated with the swing and pivot versions. For Glass sliding doors, aluminum sliding systems are also available with multiple tracks, both with the classic covering valance and in the built-in versions. For all Glass sliding doors, trolleys with integrated shock absorber are provided as standard for practical soft closing operation.

The **DS decorations** for Glass doors are made on sandblasted glass using digital printing; they allow the passage of light and are customizable in designs and colours.

Glass 2-panels sliding door | glass with DS01 sabled decoration | handles MA07

Glass 4-panels sliding door | satin silver valance PA01 | glass with DV13 decoration | handles MA06



PARTIAL DECORATION

*on glass strips
or portions*

The DV13 decoration was created in the central part of the glass on a sandblasted base, this allows the passage of light and makes the design visible also from the internal side.

GLASS WITH DOUBLE FINISH

*on the oneside and
on the other*

The door from the Glass collection with mirror, upon request, can have a different finish between the two sides, for example the outside in mirror and the inside in lacquered glass.



Glass sliding door | satin silver valance PA01 | standard mirror SP01 | handle MA07

Glass 2-glasses's sliding door | black matt valance PA03 | sandblasted glasses with DS16 decoration | handle MA06



Detail of DS16 decoration

DECORAZIONE SU VETRO SABBBIATO

*tecnologia digitale per
decorare il cristallo*

Il vetro viene decorato attraverso tre diverse lavorazioni. La prima fase consiste in una sabbatura classica, seguita da una seconda fase in cui il vetro viene decorato utilizzando un moderno sistema di stampa digitale. Infine, un trattamento protettivo viene applicato sulla parte sabbata del vetro, rendendo la superficie più facile da pulire.

Questa tecnologia permette la realizzazione di decorazioni sofisticate, con colori e disegni personalizzati. Il sistema utilizza vernici all'acqua che consentono il passaggio della luce.

Sandblasted glasses with DS16 decoration during the quality's control phases

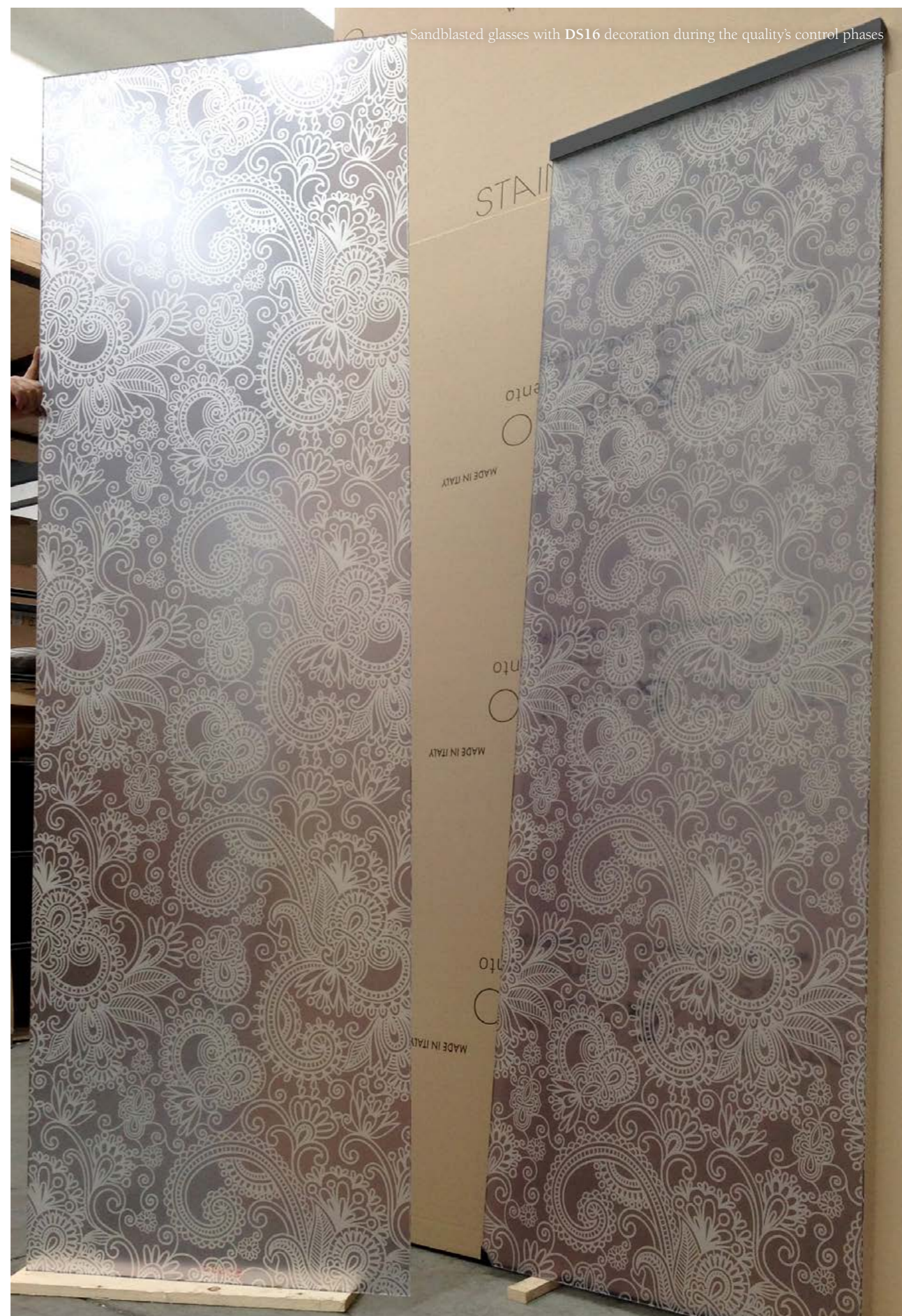

PORTFOLIO

*You can see photos of some of our creations
by framing the QR codes*



Glass 2-panels sliding door | satin silver valanche PA01 | lacquered glass J.P.Blue CL22 | handles MA04

Black & Blue

Doors from the Master, Glass and Versus collections in a prestigious project with customized finishes..



Villa in Tuscany

A villa in Tuscany, built and furnished according to the indications of the interior and lighting designer Gerardo Acciaioli by the A.D. company. design s.r.l. (addesignsrl.com).



Glass door

Connect to our website www.stainoestaino.it to see the gallery of creations.

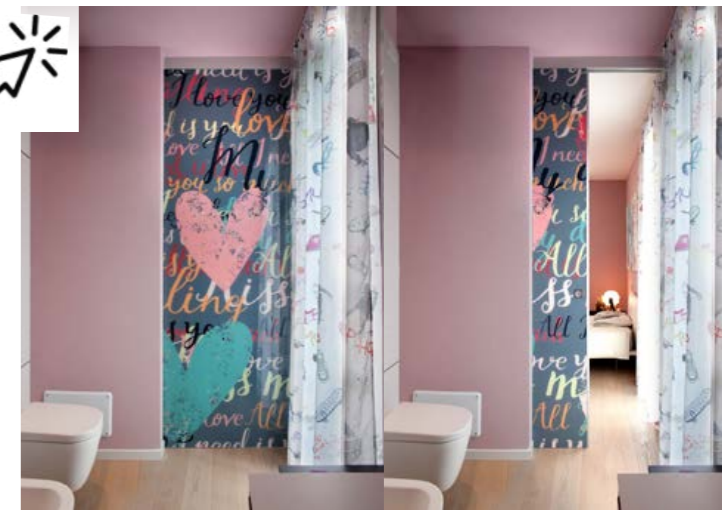

Data sheet

You can download the technical sheet dedicated to the Glass Collection from our website www.stainoestaino.it.



CATALOGUE

Segreta-S | door painted on site

operating video of the
Segreta-S door

Segreta-S

sliding coplanar door

The **Segreta door** is also available in the exclusive coplanar sliding variant "**Segreta-S**", which can be made with one or two sliding doors.

This system provides a totally mechanical operation and allows the door to be opened with a simple pressure of the hand, consequently there is no handle on the side flush with the wall.

Given the complexity of manufacturing some components and the long times required for production, the "**Segreta-S**" coplanar sliding door is available in a limited number of examples.

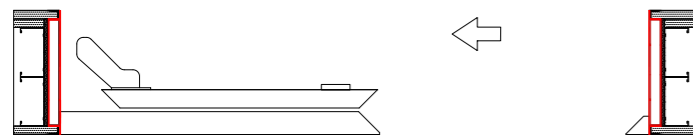
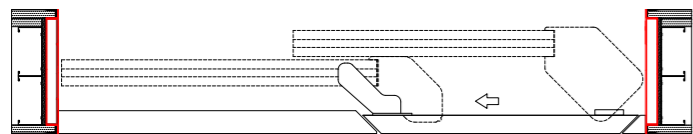

SLIDING SEGRETA-S

coplanar sliding system

The system includes a fixed and a sliding side door, the **fixed panel** becomes the wall behind which the **opening door slides**.

In addition to the two panels (fixed + openable), Segreta-S is equipped with a special perimeter frame where, already in the factory, the sliding system is fixed, all specifically designed to guarantee the **best possible flush-to-the-wall effect**.

Segreta-S | door painted on site

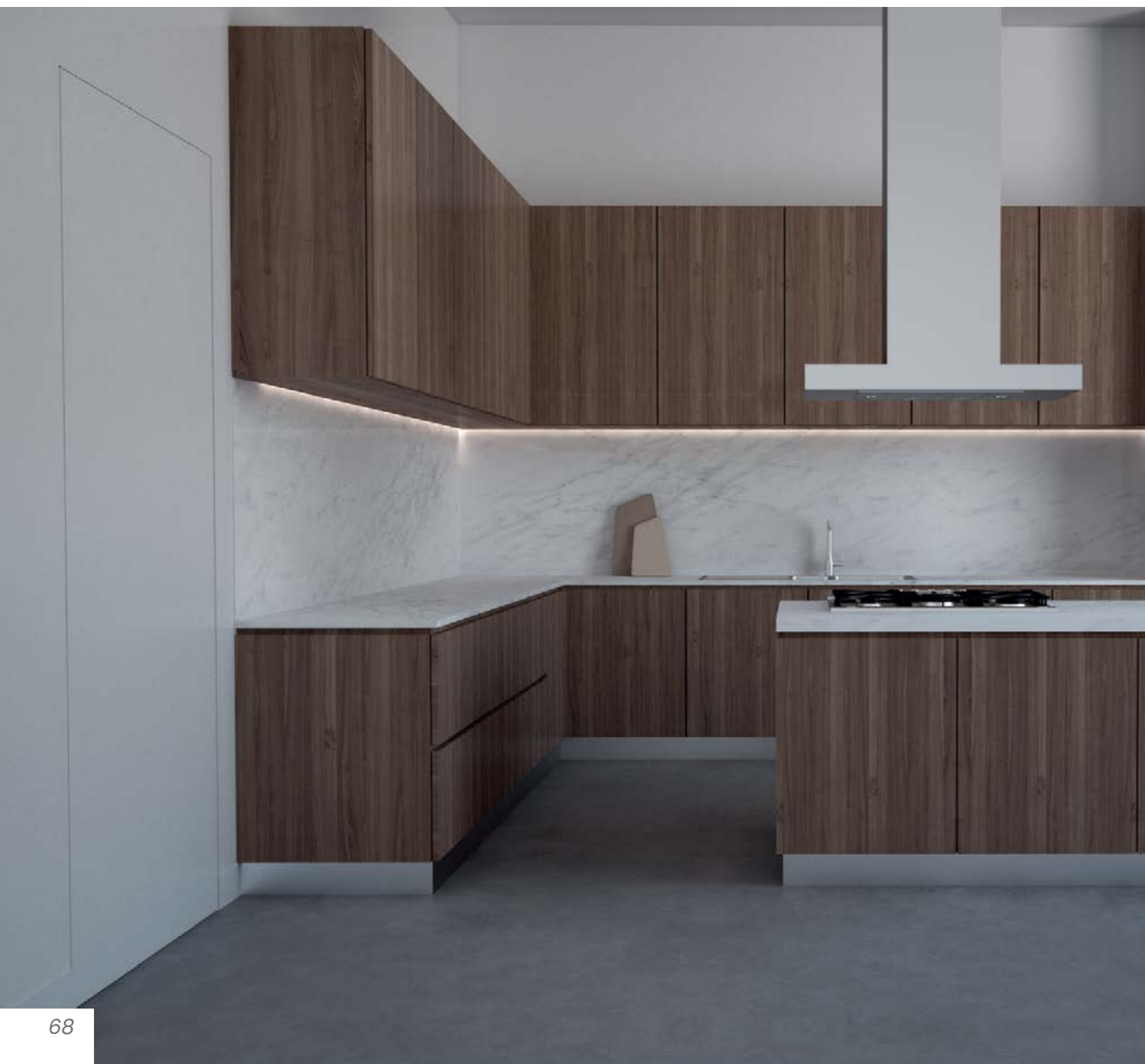

SLIDING SEGRETA

outside the wall

The **external wall** sliding door, made with 1 or more leaves, is always produced to measure up to 130 x 300 h cm.

The doors can be supplied already lacquered or in a version to be painted.

The **sliding track** can be of the **built-in type** or in the **classic version** with covering valances.

Also for the sliding «Segreta», various types of optional handles are available such as the **MA 22 groove handle** model in the photo.



Segreta sliding door | painted on site | niches MA03

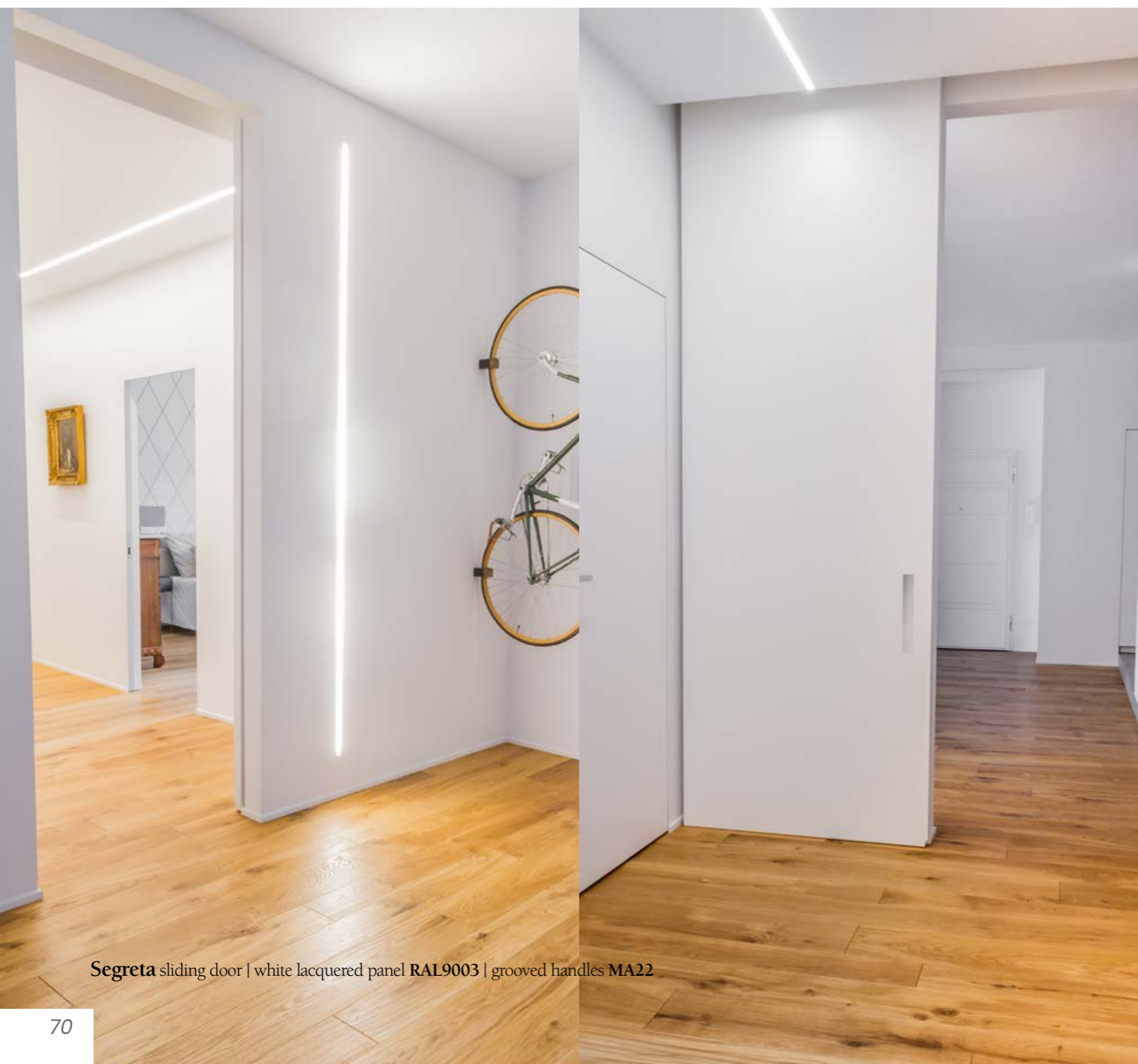

Segreta sliding door | white lacquered panel RAL9003 | grooved handles MA22

SLIDING SEGRETA

inside the wall

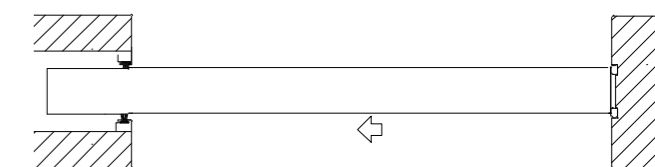

The Segreta door is available in an internal-wall sliding version and is compatible with all counterframe models on the market.

The company can supply the **complete door** and **counterframe kit**, or just the prepared door.

Internal sliding secret wall is equipped with recessed handles in satin chrome (as in the photo) or matt white; other types of handles are available on request.

PORTFOLIO

*You can see photos of some of our creations
by framing the QR codes*



Segreta-S coplanar sliding door | door painted on site

Coplanar sliding door

The Segreta invisible door is also available in the coplanar sliding version, made to measure to the millimeter in the one or two-leaf version.

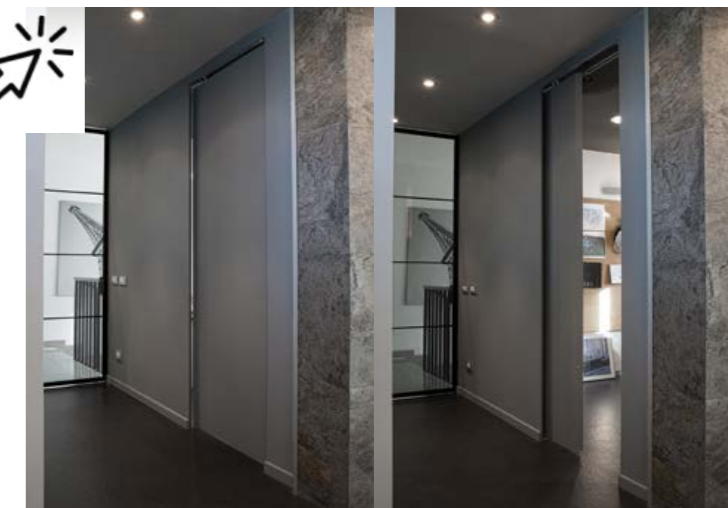

Buontalenti Palace

The historic Palace is renewed thanks to the project signed by MATTEINI + ASSOCIATES (www.matteiniassociates.com).

Numerous closures have been created with the Segreta and Segreta double flush-to-the-wall collections.



Family House

A modern renovation according to the project of the architects Filippo Cambi and Petula Bolognesi. The type of products included is very varied: Segreta, Light, Master and Versus internal doors.



Complete Catalogue

You can download the technical sheet dedicated to the Segreta Collection from our website www.stainoestaino.it.



CATALOGUE



Collection Versus

The **Versus sliding system** is specifically designed to create wall wardrobes tailored to the millimeter and, thanks to its technology, allows you to close any type of space from wall to wall and from ceiling to floor.

The system developed around this profile allows you to create doors that can accommodate glass, decorated glass or mirrors.

The aluminum is available in a satin version, lacquered in various matt colours, in bronze and dark bronze finishes, or in a sample matt colour. The ground track guarantees insulation from the outside and better protection from dust as well as supporting the weight of the doors which can thus be mounted without problems even in the case of false ceilings.

To best equip the wardrobe compartment, a series of accessories are available such as shelves, coat hangers and drawers, also made to measure.

Versus 6-sliding panels closet | satin silver profile PA01 | lacquered glass on sample | handles MA07



Versus sliding system | satin silver profile PA01 | lacquered glass on sample | handles MA07

FLOOR TRACK

The floor track guarantees excellent protection from dust as well as supporting the weight of the doors which can thus be mounted without problems even in the case of false ceilings.

The sliding tracks can be recessed into either the floor or the ceiling.





Versus 4-sliding panels closet | matt white profile PA02 | white lacquered glass CL03 | handles MA09

MA09 HANDLE

Specially designed for the four-door version, the **MA-09** handle allows a correct grip even at the meeting point of the two central doors.

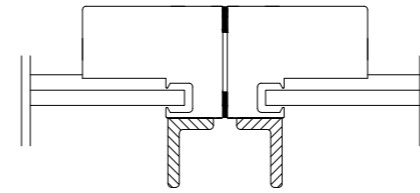

PORTFOLIO

*You can see photos of some of our creations
by framing the QR codes*



Versus sliding system | satin silver profile PA01 | silver satin nervuré mirror SP05 | handles MA07

Black & Blue

Doors from the Master, Glass and Versus collections in a prestigious project with customized finishes.



City Home

Numerous doors from the Staino&Staino Easy-S, Versus and Revolution® collections were included in the renovation of an important city villa.



Family House

A modern renovation according to the project of the architects Filippo Cambi and Petula Bolognesi. The type of products included is very varied: Segreta, Light, Master and Versus internal doors.



Villefranche Sur Mer

An important work inside a splendid villa that enjoys a fantastic view of the sea of the French Riviera. The most important and voluminous rooms have been closed with sliding doors from the Versus collection.



Handles

*Data sheets and
operating videos*



Easy-S sliding door | sandblasted iron grey profile PA13 | transparent glass CR01 | crosspieces Three | handles MA17

RECTANGULAR HANDLES

MA17

The pair of **MA-17** handles is available in all the finishes foreseen for the Easy-S or Extra Light door profile.

They are made from solid aluminium, with a height of 170 mm, and are supplied as standard with a sliding door.

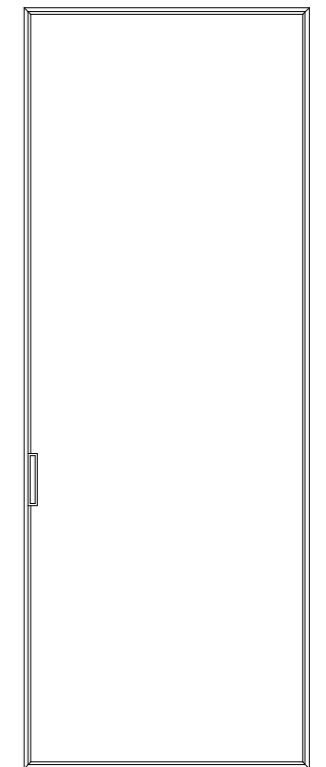
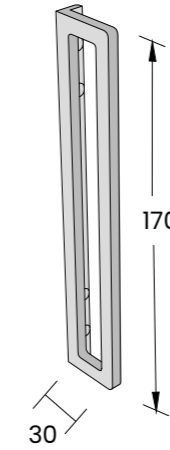
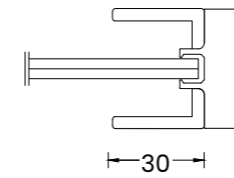

ALUMINUM HANDLES

MA07

Pair of **MA-07** aluminum handles H 340 mm. Standard handle for the Glass and Versus collections.

Not available for 4-door Versus.

These handles require the elimination of the lock and the installation of a magnet on the stop.

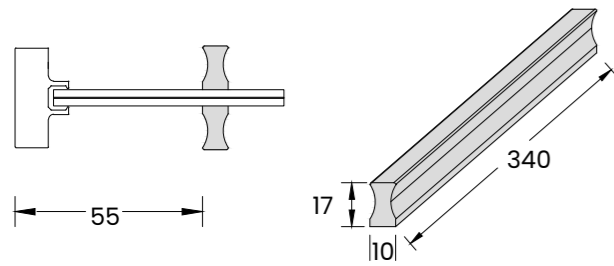

NICHES & PAWL

MA03

Pair of square recessed niches with latch. Satin or polished chrome privacy latch.

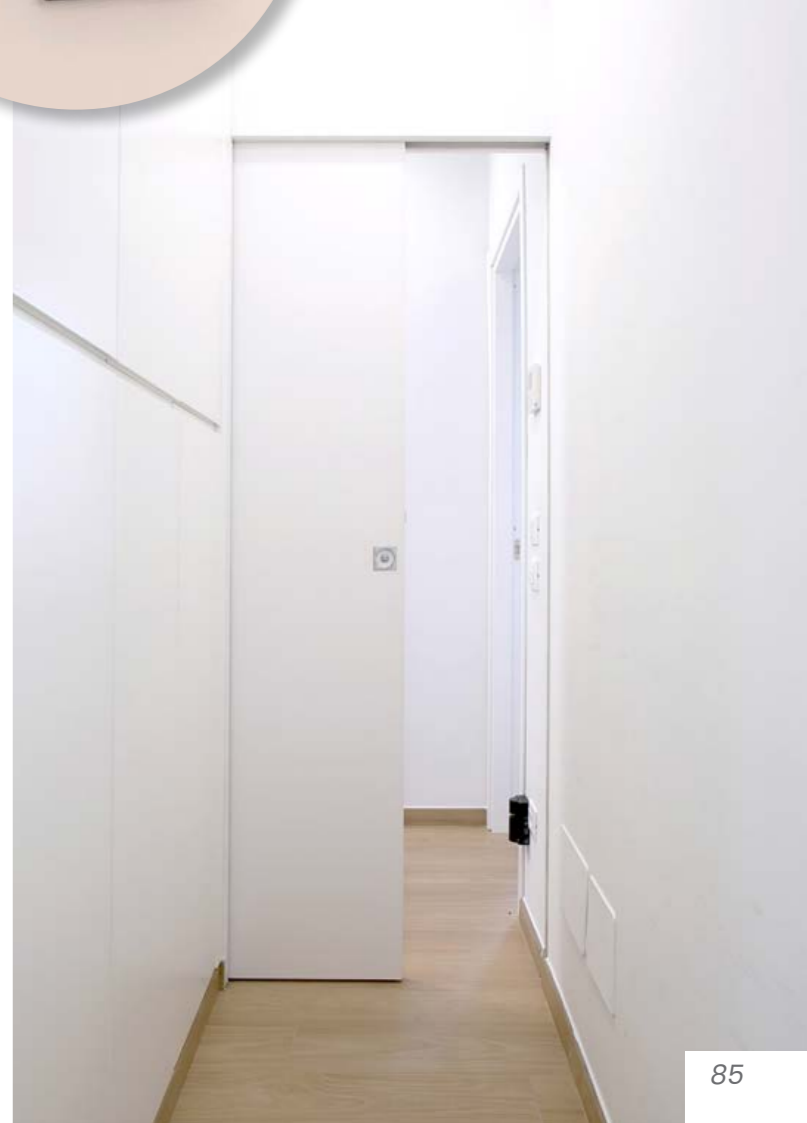
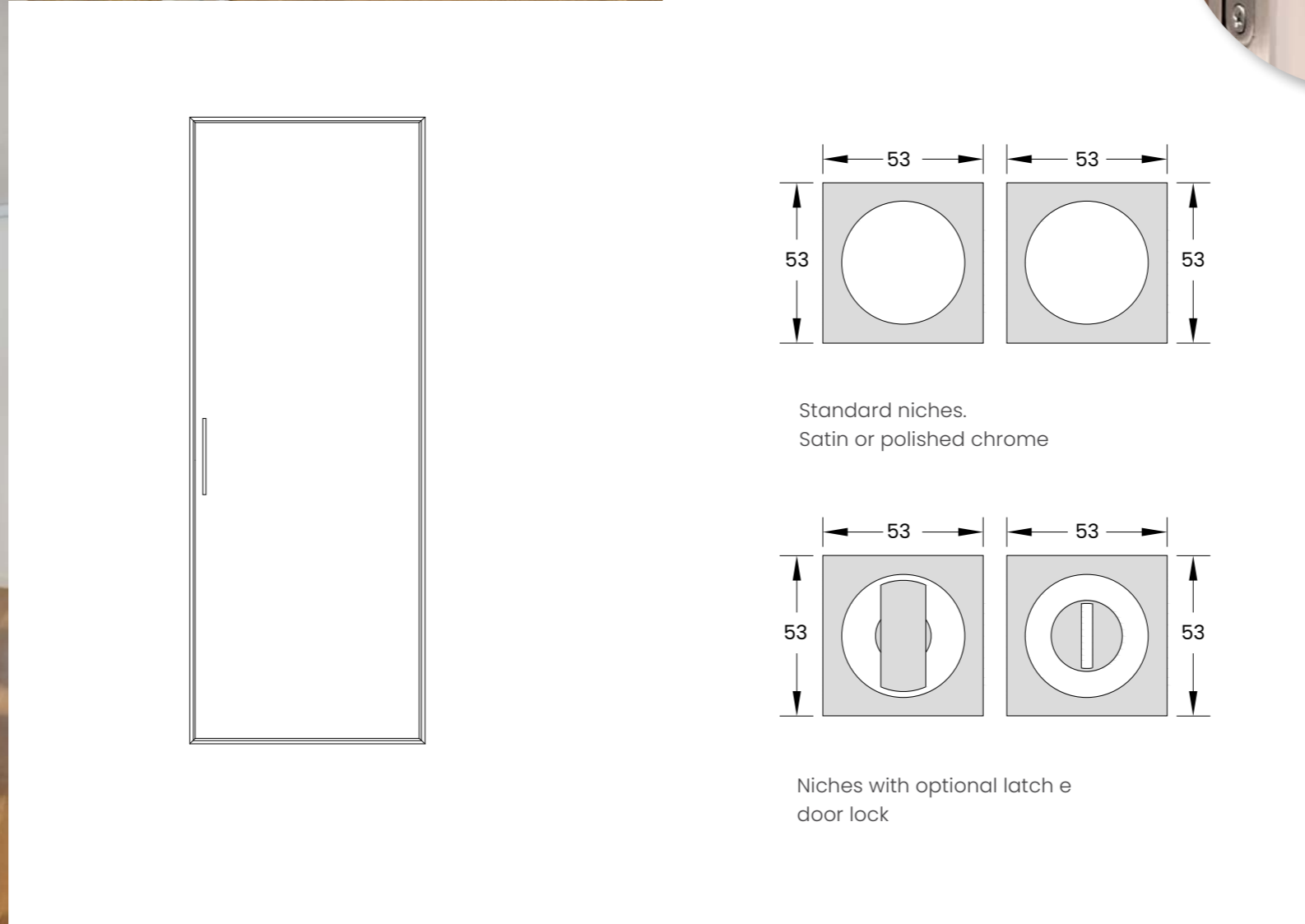

GROOVED HANDLES

MA22

Magnetic closure and **MA-22 groove handle**: the simplest combination for the Segreta door.

Upon request it is possible to add a privacy closure or a lock with key.

Pair of handles 40x200 mm H

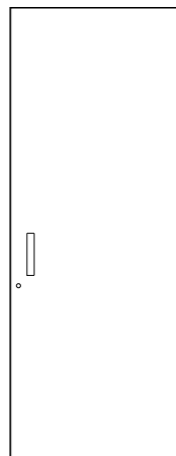
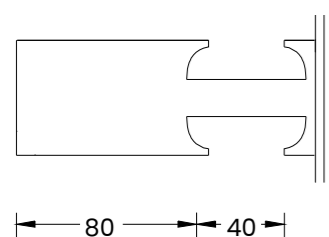

click on the icon to **watch the video** operation of the **MA-22** handle



ALUMINUM HANDLES

MA25

MA-25 handle machined from solid aluminum, finish coordinated with the door profiles.

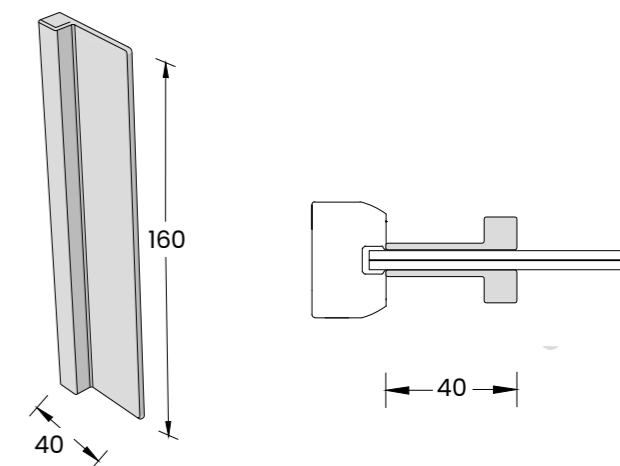

GROOVED HANDLES

MA23

Pair of 40 mm groove handles.
Possible combinations:

- Pair of handles with long **MA-23** groove on both sides;
- Pair of handles with long **MA-23** groove on the outside and short **MA-22** groove on the inside.

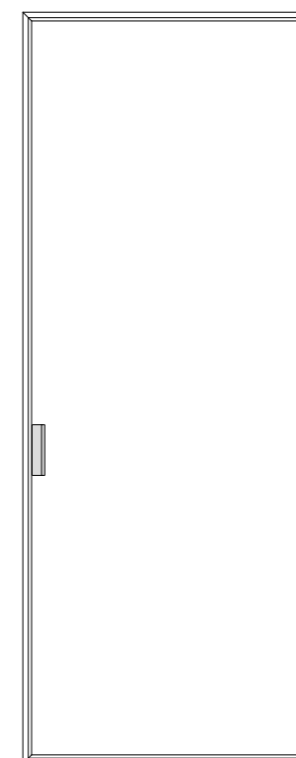
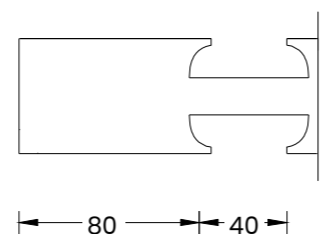
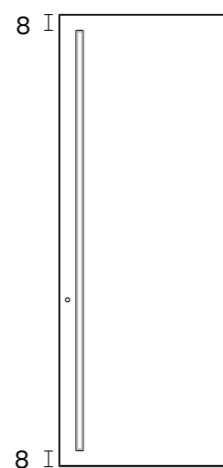

ALUMINUM HANDLES

MA09

MA-09 handle machined from solid aluminium, finish coordinated with the door profiles. Standard handle for the Extra Light and Versus 4-door collection.

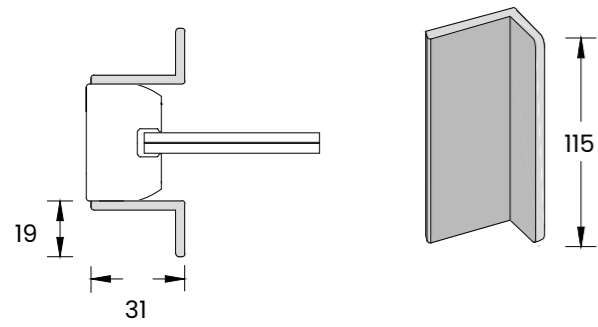

OPTIONAL HANDLES:

- Pair of aluminum handles H mm 560 **MA-05**
- Pair of satin stainless steel handles H 149 cm **MA-06**
- Pair of stainless steel handles H 140 cm **MA-04**
(Only available on tempered glass)

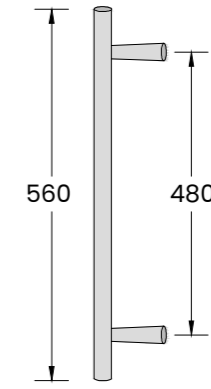
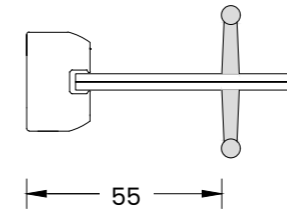
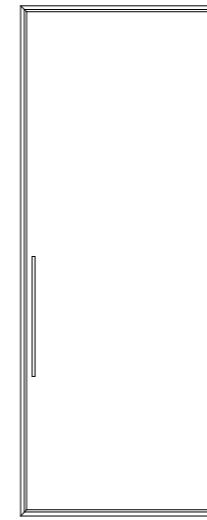

MA05

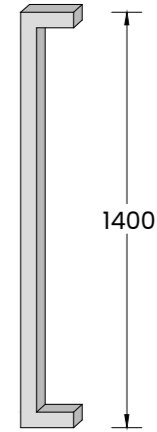

MA04

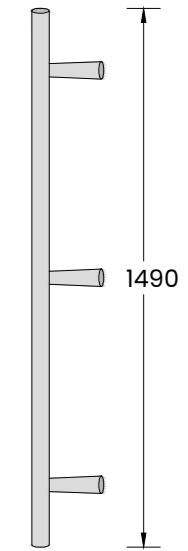

MA06

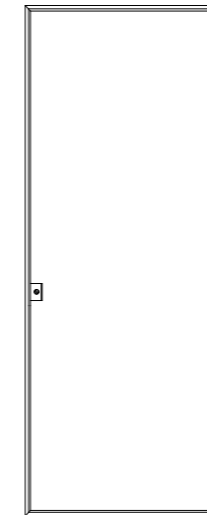

Handle machined from solid aluminum with integrated lock, includes privacy latch. It is supplied in a finish coordinated with the perimeter profiles of the door. The privacy latch is available in satin chrome, polished chrome or matt white or black lacquered finish. Available only on tempered glass. The use of the wall upright to match the lock is mandatory.

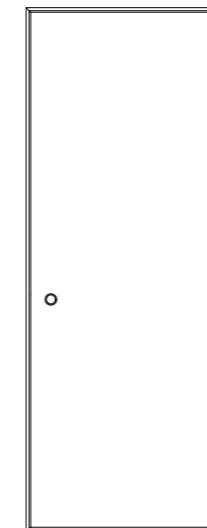
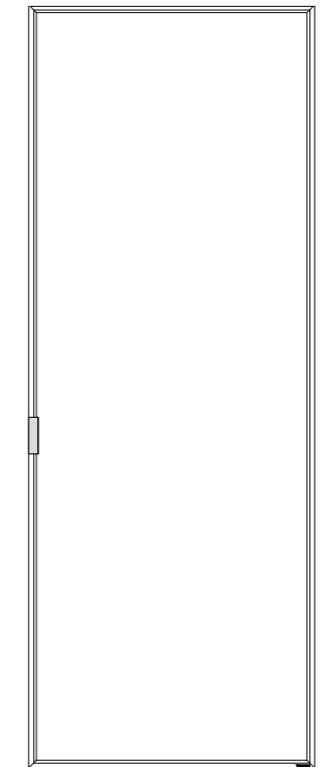
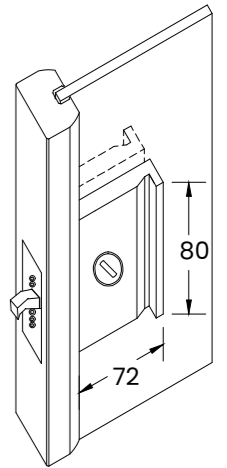
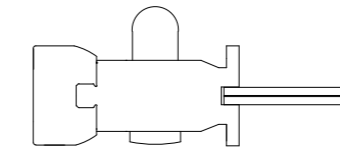

Ring with **MA-20** through hole with 40 mm diameter for sliding doors from the Extra Light, Easy-S and Glass Collections. Available only on tempered glass.

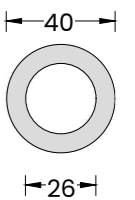
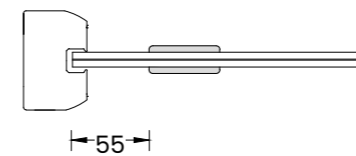

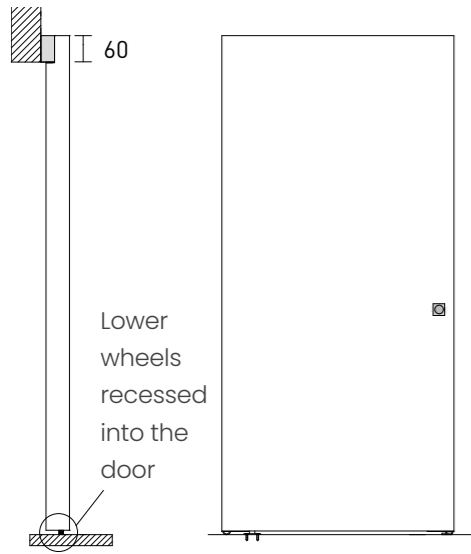

MAGIC SLIDING SYSTEM

Invisible opening system

Invisible sliding system with **wall attachment**.

The **Magic sliding system** also uses lower wheels on the floor, for this feature it is necessary to use this system in the presence of smooth floors without joints such as, for example, parquet or resin.

Segreta sliding door | painted on site | groove handles MA22 | invisible opening Magic

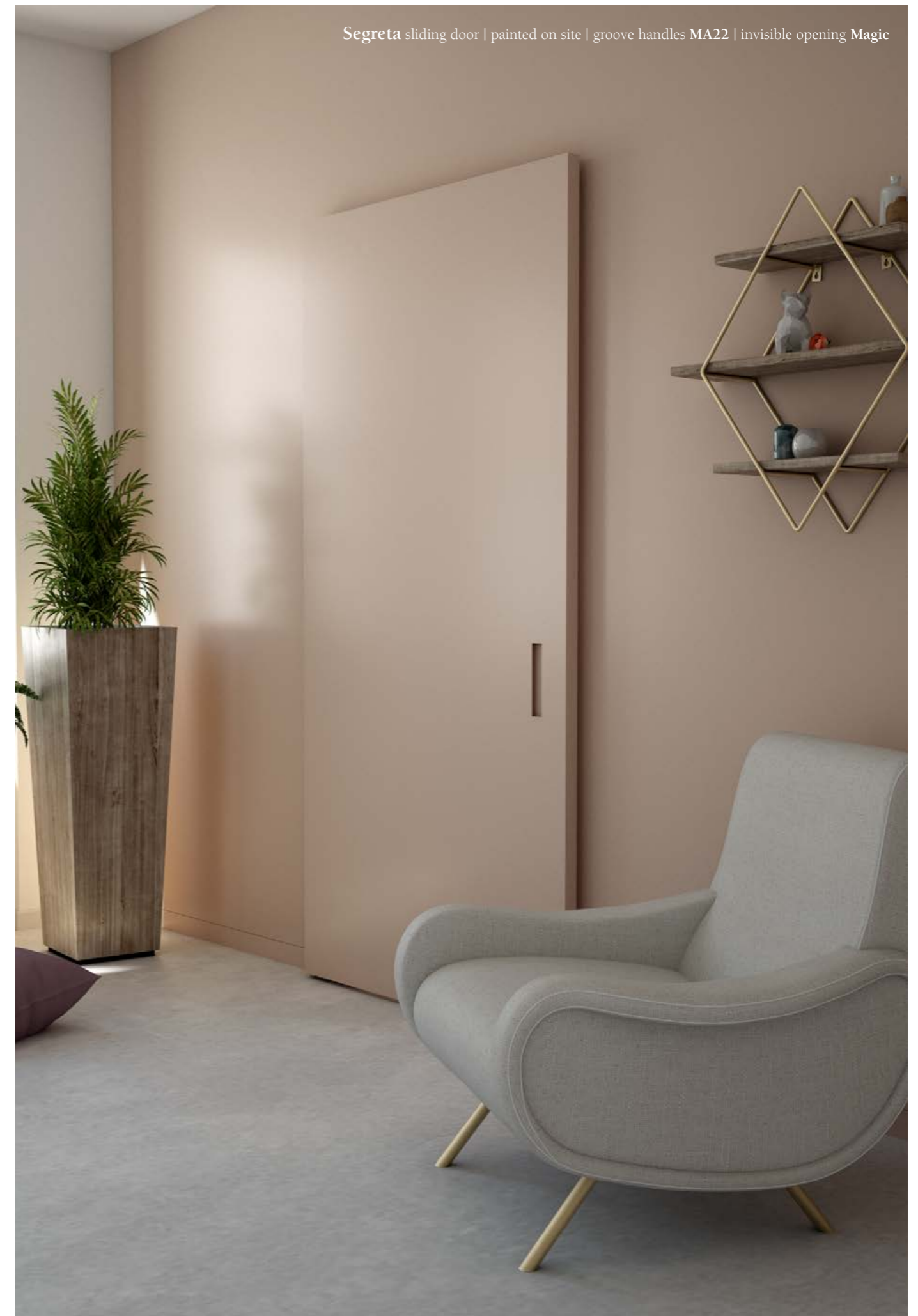
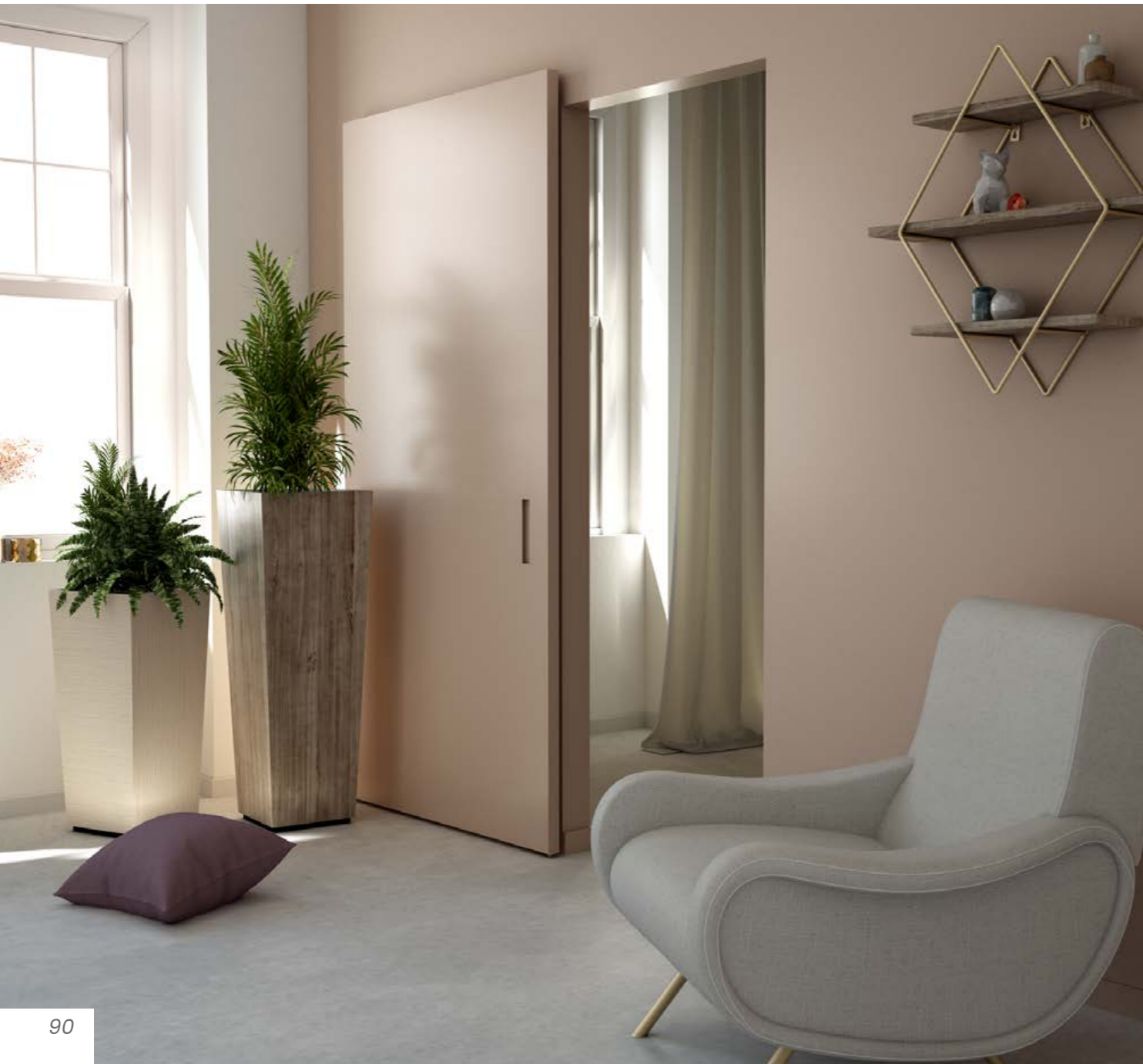

FREE PASSAGE FROM THE DOOR

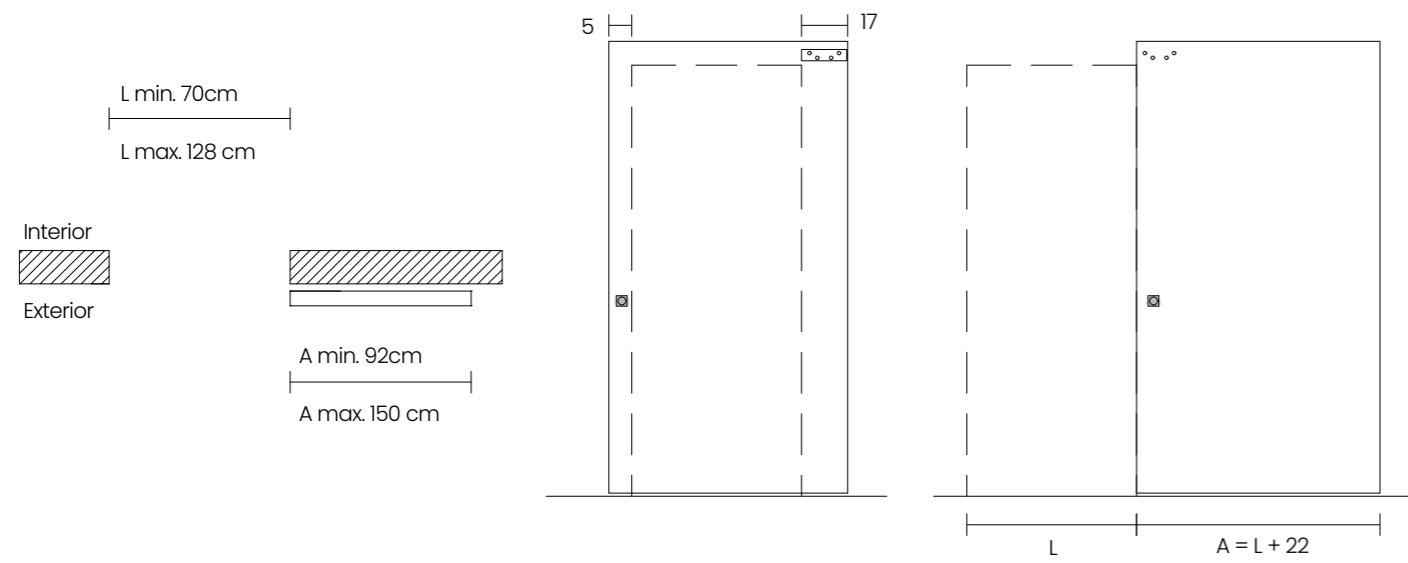

PASSAGE WITH DOOR IN 12CM SPAN

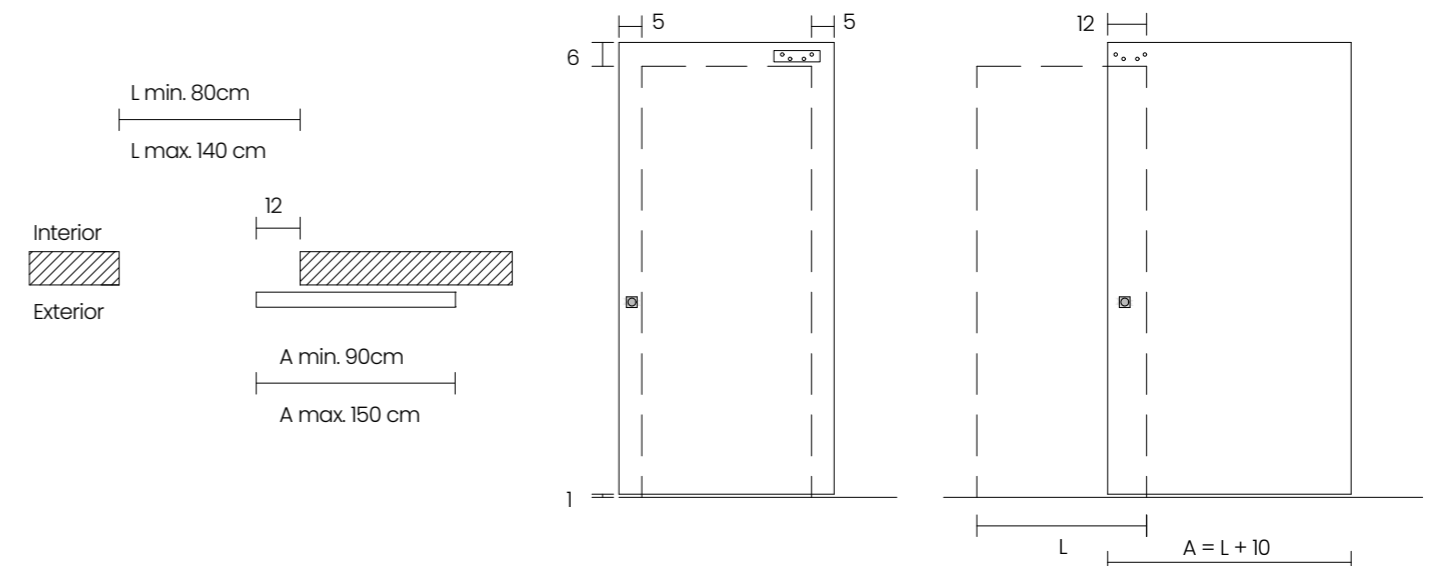

Data sheets

Sliding openings
outside the wall



Easy-S 2-panel sliding door | iron grey sabled profile PA13 | transparent glass CR01 | crosspieces Three | handles MA17

STAINO&STAINO SLIDING SYSTEMS TYPOLOGIES:

For personalized feasibility requests write to:
commerciale@stainoestino.com

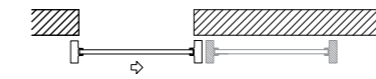

Sliding door with single track, wall or ceiling attachment.

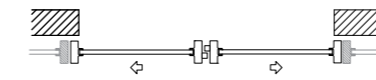

Double door with single track, wall or ceiling attachment.

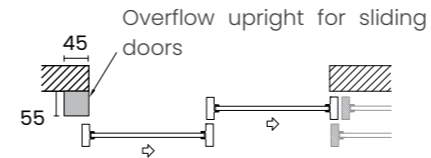

Double door, two-way sliding track with ceiling or wall attachment.

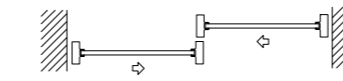

Double door, two-way sliding track with ceiling attachment.

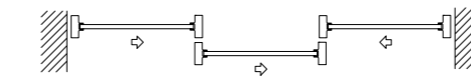

Triple door, two-way sliding track with ceiling attachment.

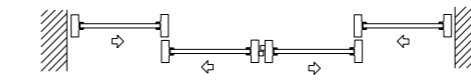

Four-panel door, two-way sliding track with ceiling attachment.

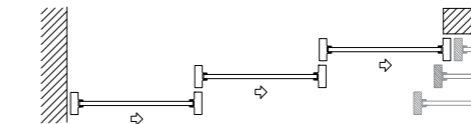

Triple door, three-way sliding track with ceiling attachment.

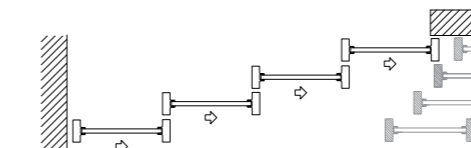

Four-panel door, four-way sliding track with ceiling attachment.

Tracks with valance

Adjustable built-in tracks

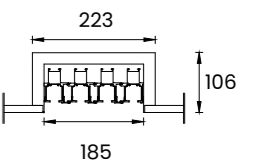
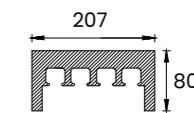
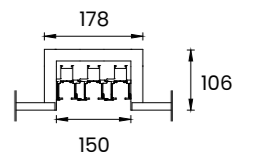
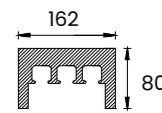
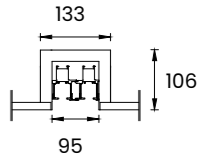
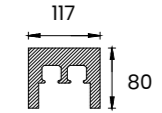
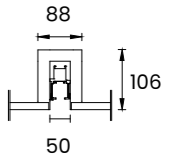
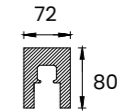

*examples of sliding openings based on the number of doors. It is possible, upon request, to create other types of opening.

Data sheets

Sliding Easy-S door

SLIDING DOOR

The Easy-S sliding door is always made to measure with maximum dimensions of 130 x 300 h cm (net passage).

The Easy-S sliding door is equipped with a pair of **MA-17** standard handles (figure below) on the external/internal side.

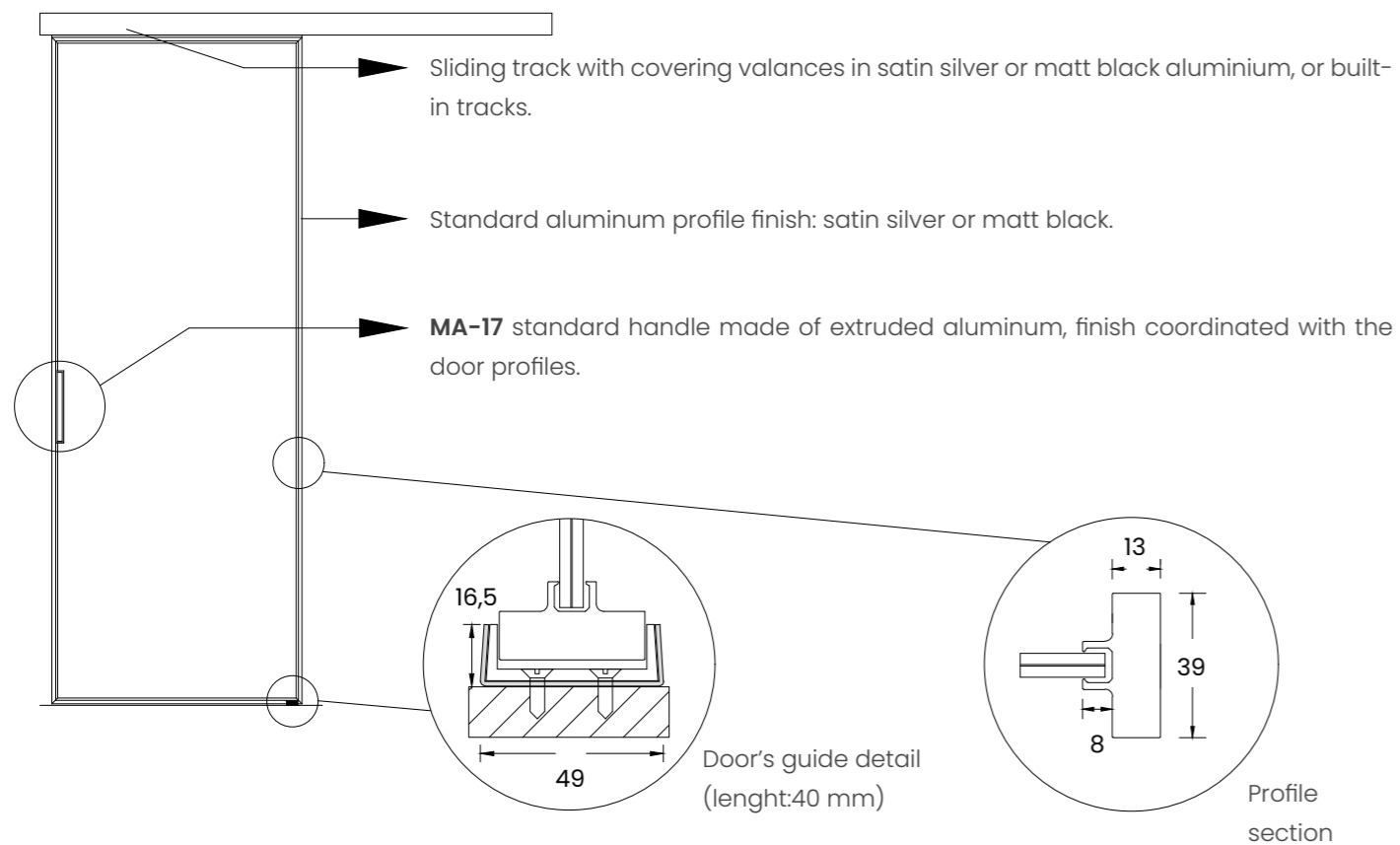

Handle type MA17

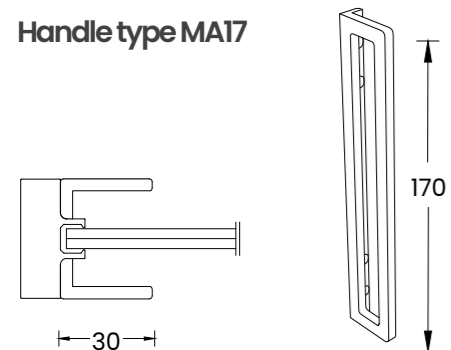

WALL PROFILE FOR AIR REDUCTION

It is possible to install a 12 x 12 mm section profile on the wall to reduce the air between the door and the wall.

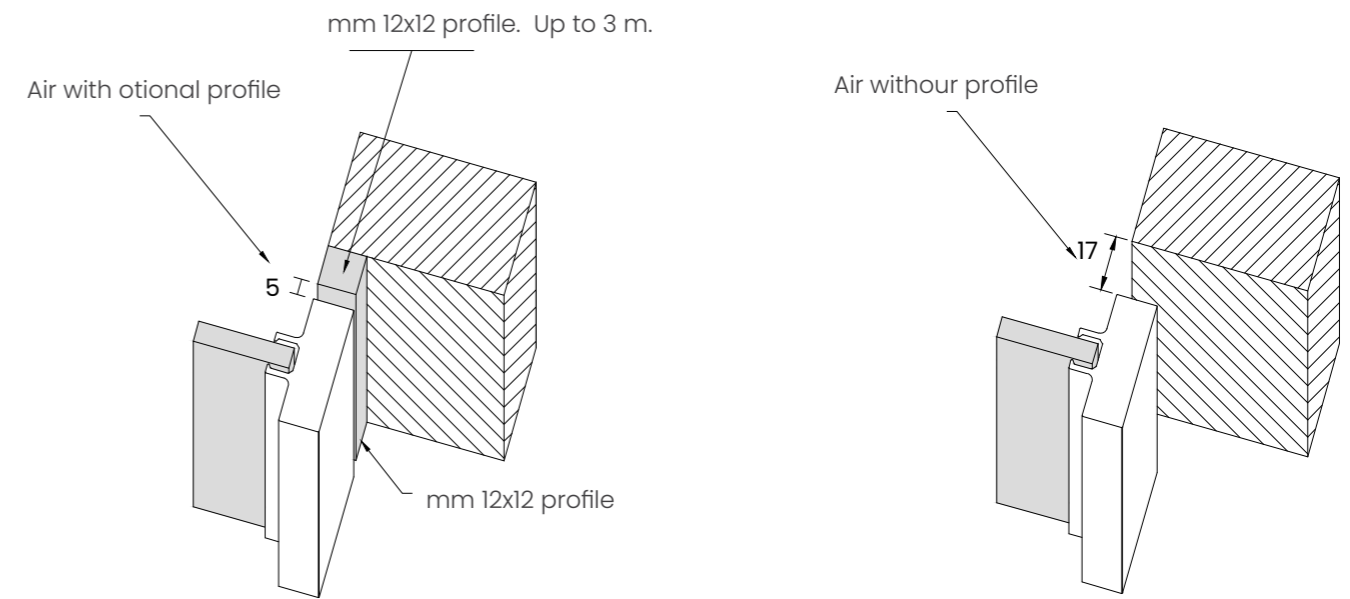

SIDE JAMB

Optional side jamb includes a closing striker of mm 10 x 10 added on the door's profile.

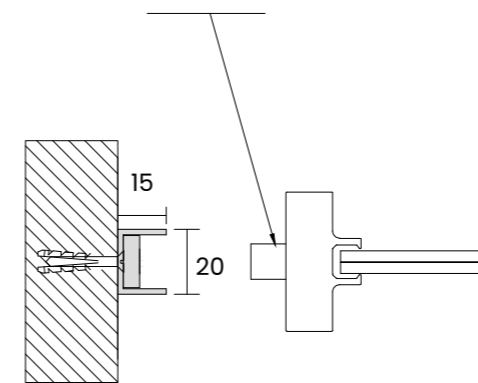

Both the side jamb and the central joint profile are made of extruded aluminum coordinated with the door.

CENTRAL JOINT PROFILE

Central joint profile for two-panels sliding door that includes a mm10x10 profile on the closing side of each panel.

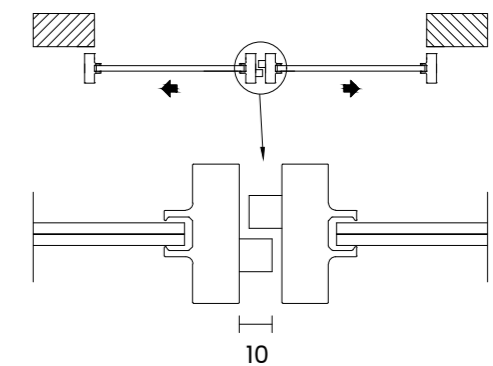

The central joint profile allows you to avoid the light between the door's panels.

Data sheets

Sliding Extra Light door

SLIDING DOOR

The Extra Light sliding door is always made to measure with maximum dimensions of 130 x 300 h cm (net passage).

The Extra Light sliding door is equipped with a pair of **MA-09** standard handles (figure below) on the external/internal side.

Rollers with soft stop on closing and soft stop on opening: standard.

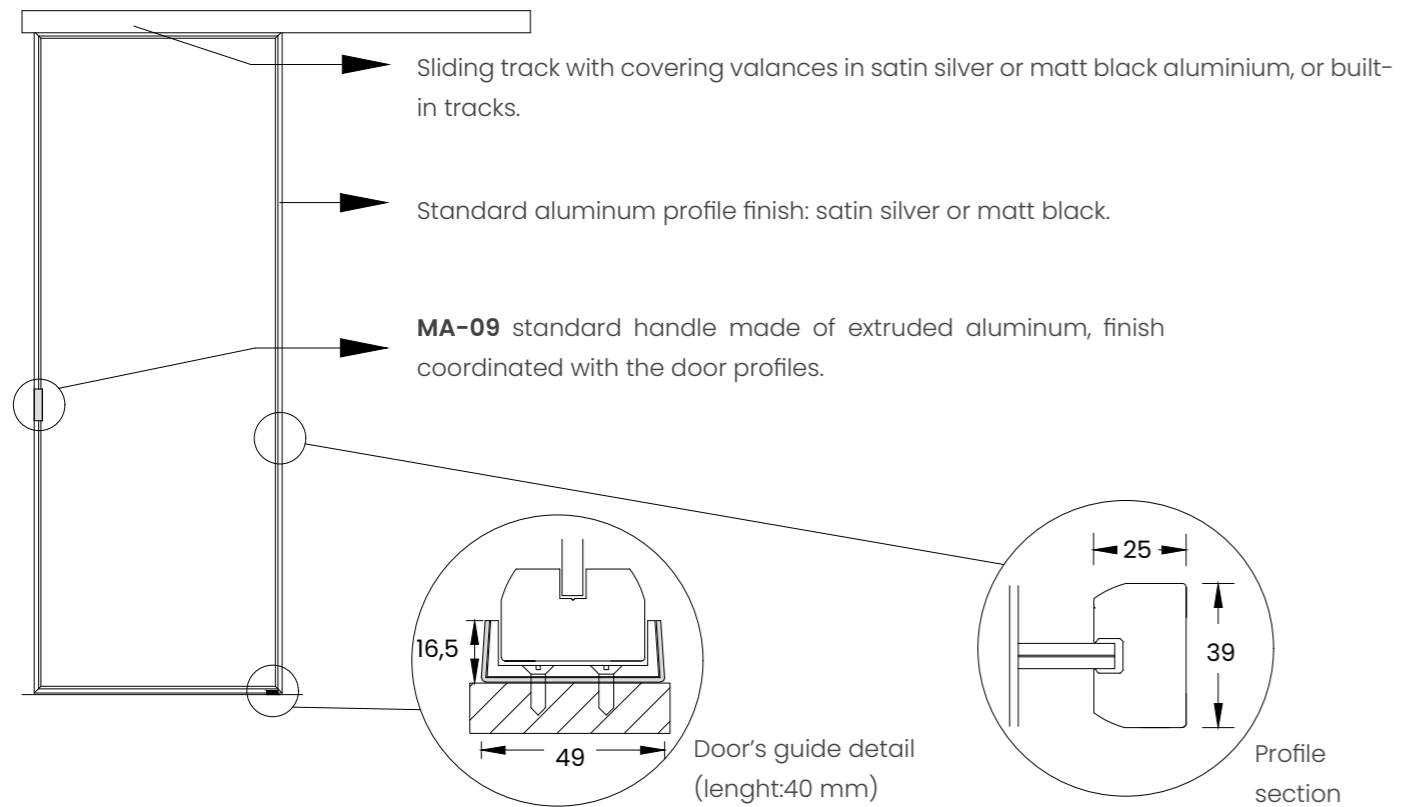

Handle type MA09

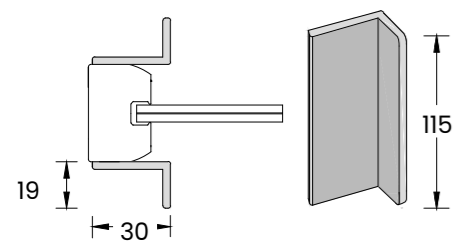

WALL PROFILE FOR AIR REDUCTION

It is possible to install a 12 x 12 mm section profile on the wall to reduce the air between the door and the wall.

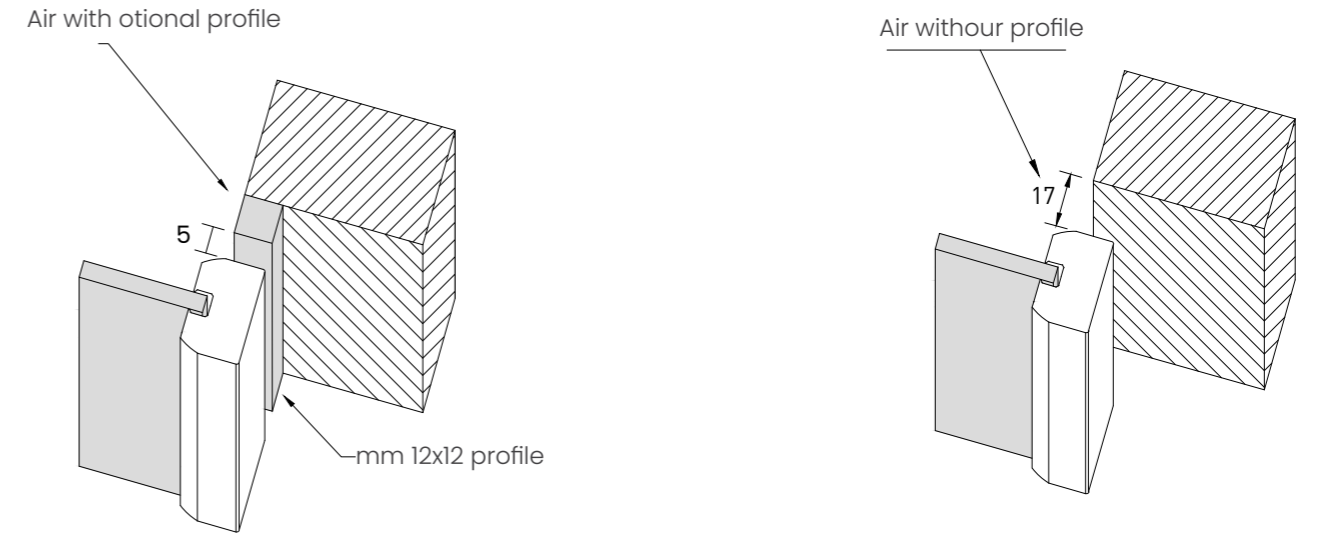

VERTICAL SIDE JAMB

Optional vertical side jamb sized mm 55 x 40, mandatory for matching the hook lock.

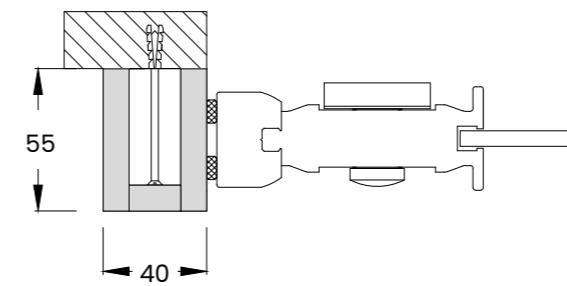

Both the side jamb and the central joint profile are made of extruded aluminum coordinated with the door.

Optional side jamb includes a closing striker of mm 10 x 10 added on the door's profile.

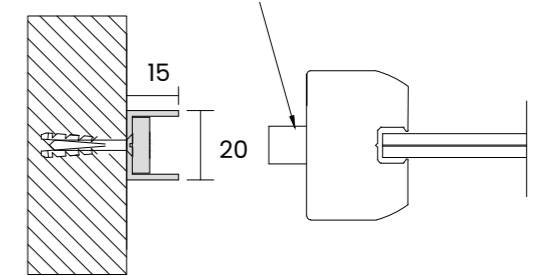

This profile allows you to avoid the light between the door's panels.

Data sheets

Sliding Glass door

SLIDING DOOR

The Glass sliding door is always made to measure with maximum dimensions of 130 x 300 h cm (net passage).

The Glass sliding door is equipped with a pair of **MA-07** standard handles (figure below) on the external/internal side.

Rollers with soft stop on closing and soft stop on opening: standard.

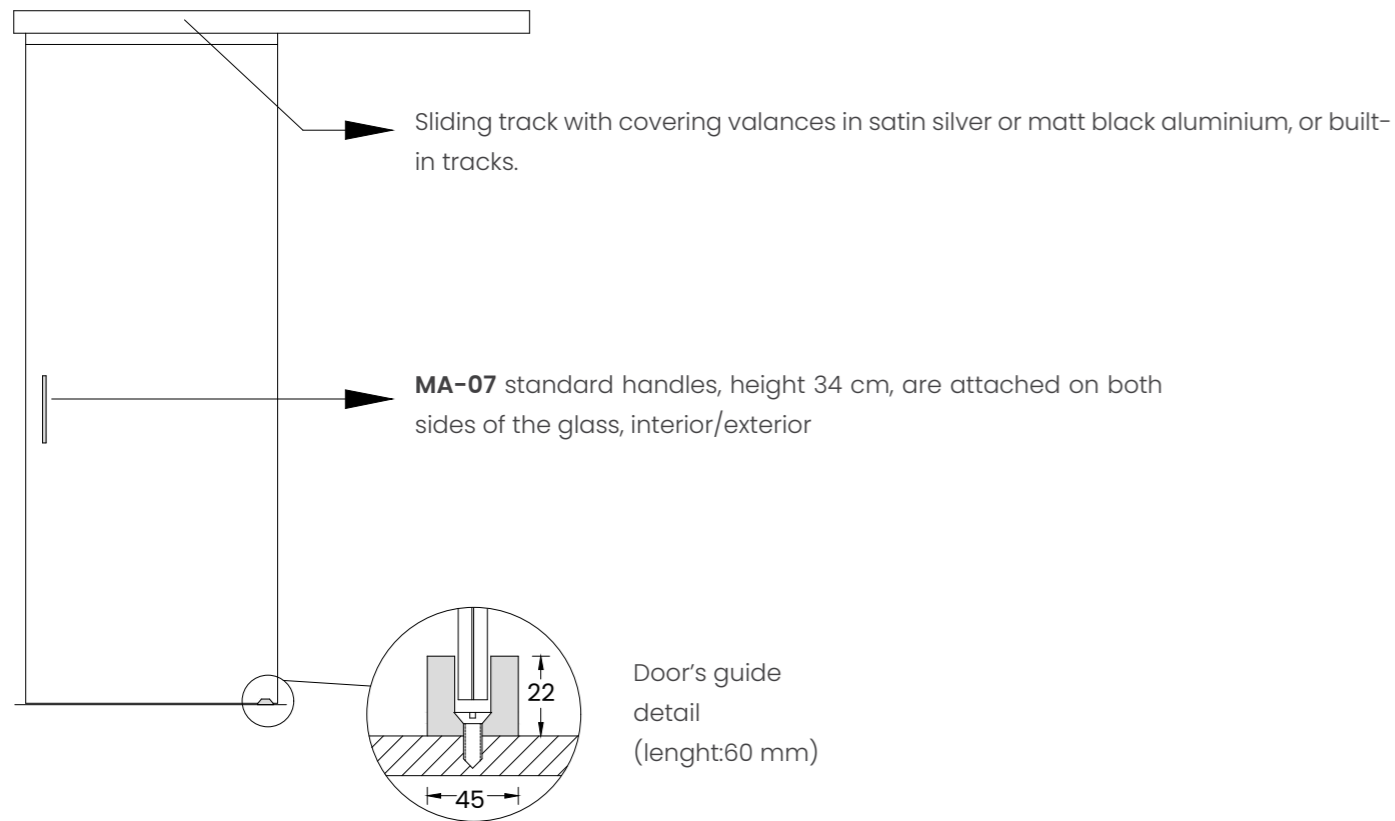

Handle type MA07

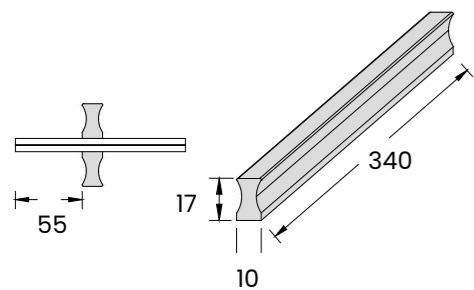

VERTICAL SIDE JAMB

Optional vertical side jamb sized mm 55 x 40, mandatory for matching the hook lock.

Wall side jambs made of satin silver aluminium.

Transparent strike seal to be glued onto the thickness of the glass

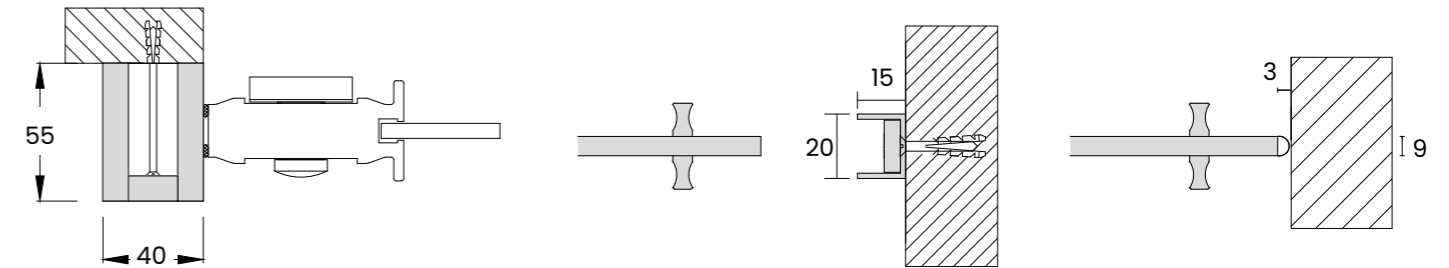

SLIDING TRACK WITH VISIBLE MECHANICS

Satin-finish AISI 304 stainless steel sliding system consisting of two carriages and a round-section track with visible studs. Available with a one-way track and wall mounting. This system is only suitable for use with tempered glass.

A soft-closing option is not available for this system

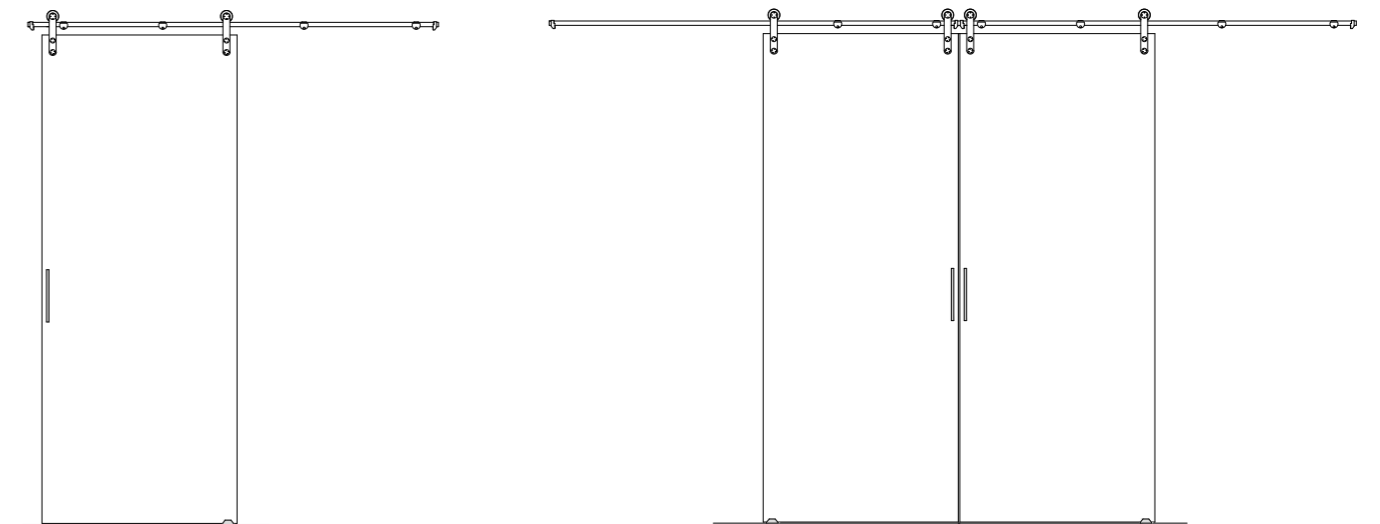

SLIDING TRACK WITH VISIBLE ALUMINUM CLAMPS

The sliding system with visible clamps is available with a one-way track and wall mounting, the standard finish is satin silver aluminium, and a closing damper is included in the price.

This system is only suitable for use with tempered glass.

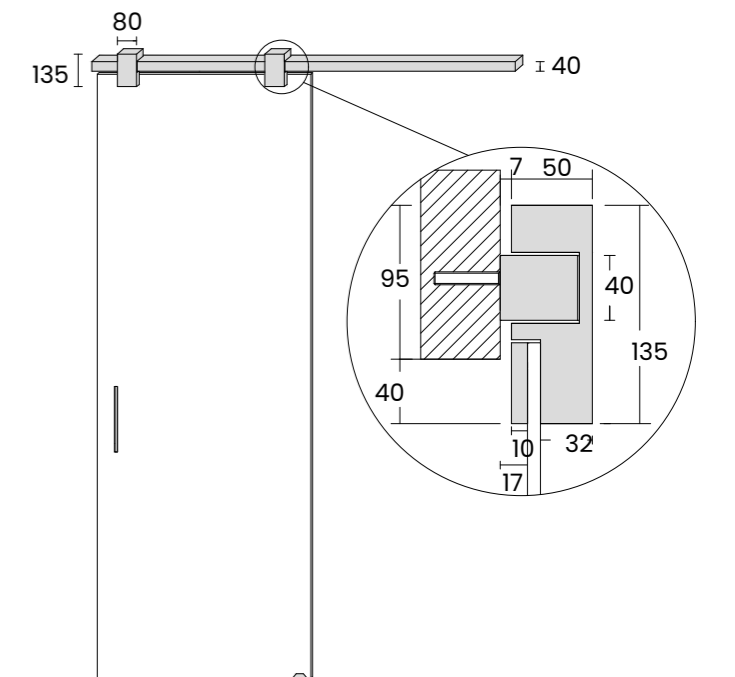

Data sheets

Sliding Master door

SLIDING DOOR OUTSIDE THE WALL

The Master sliding door is always made to measure with maximum dimensions of 130 x 300 h cm (net passage).

The Master sliding door is equipped with a pair of **MA-03** standard handles (figure below) on the external/internal side.

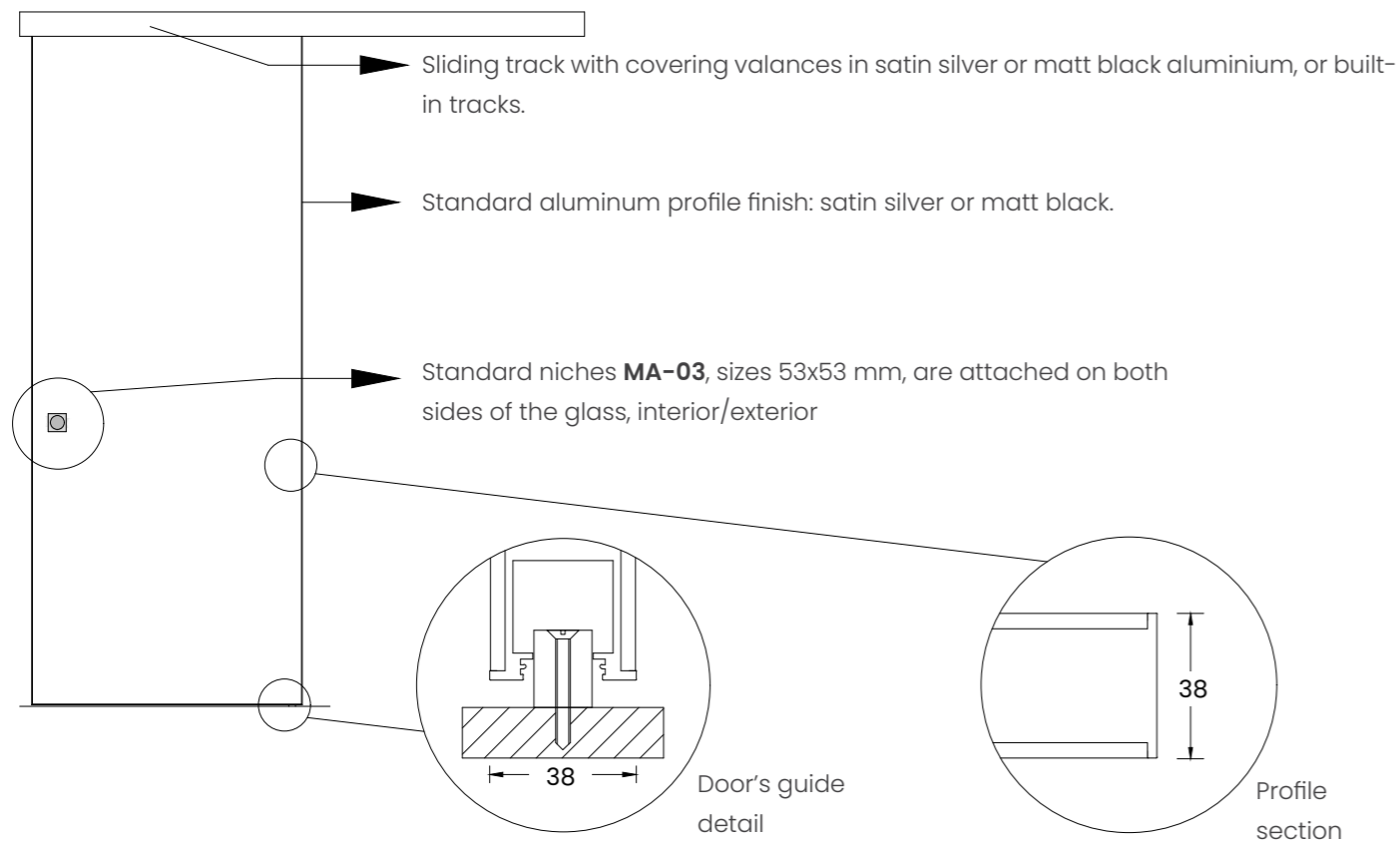

Handle type MA03

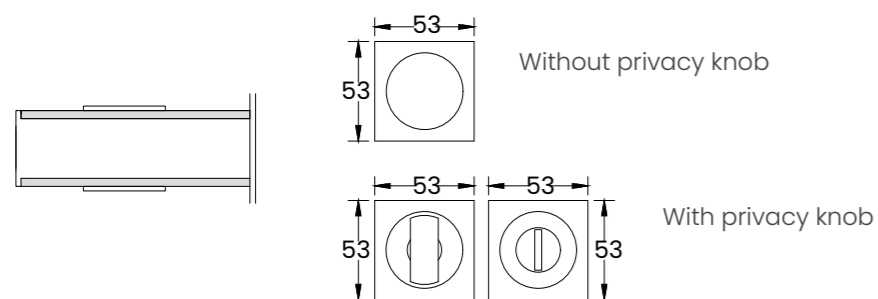

MASTER SLIDING IN-WALL SYSTEM FOR CLASSIC CASINGS

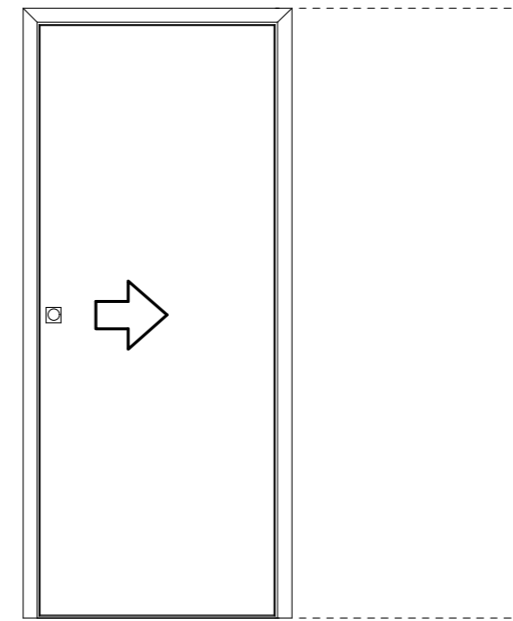

MASTER SLIDING IN-WALL SYSTEM FOR FLUSH-MOUNTED CASINGS

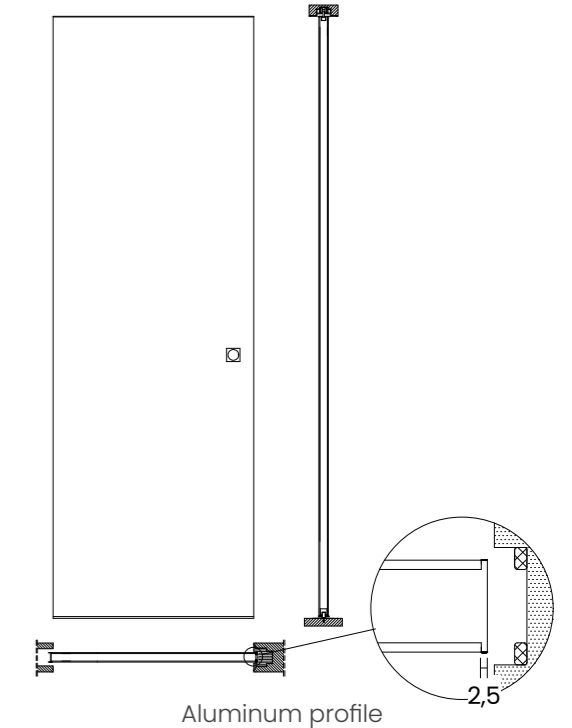

WALL PROFILE FOR AIR REDUCTION

It is possible to install a 20 x 10 mm section profile on the wall to reduce the air between the door and the wall.

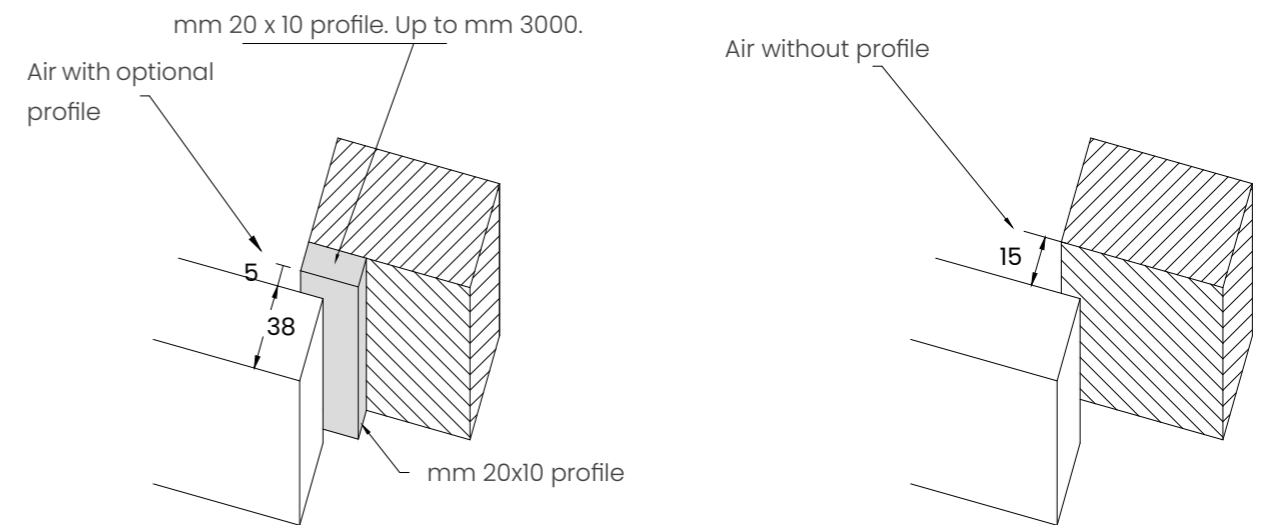

VERTICAL SIDE JAMB

Optional vertical side jamb sized mm 55 x 40, mandatory for matching the hook lock.

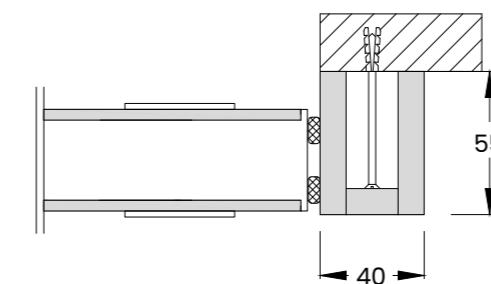

The side jamb is made of extruded aluminum coordinated with the door.

Optional side jamb includes a closing striker of mm 10 x 10 added on the door's profile.

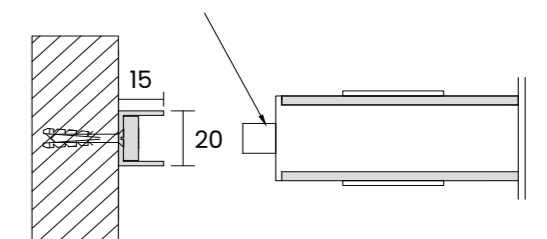

This profile allows you to avoid the light between the door's panels.

Data sheets

Sliding door Segreta

SLIDING DOOR OUTSIDE THE WALL

The Segreta sliding door is always made to measure with maximum dimensions of 90 x 220 h cm (net passage).

Rollers with soft stop on closing and soft stop on opening: standard.

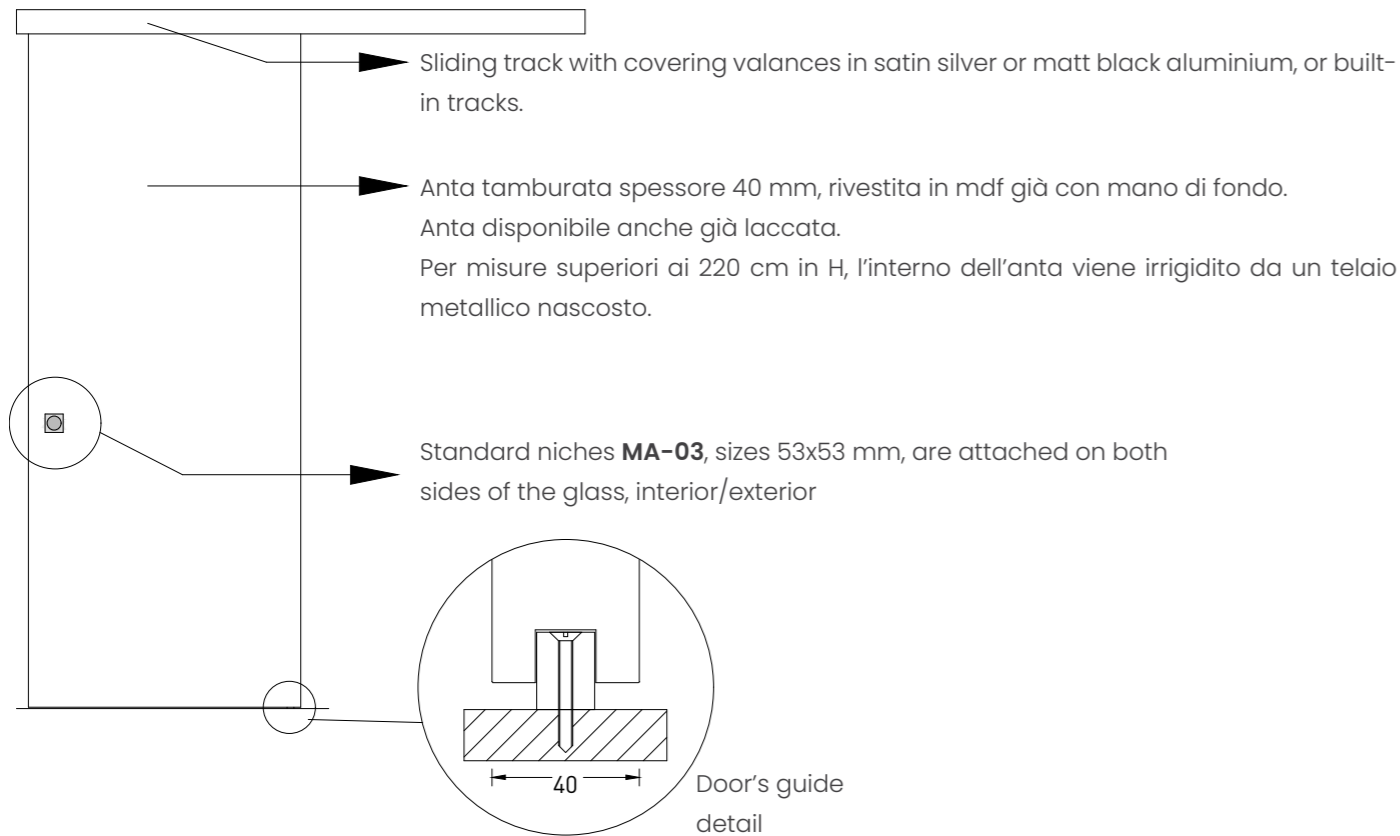

Handle type MA03

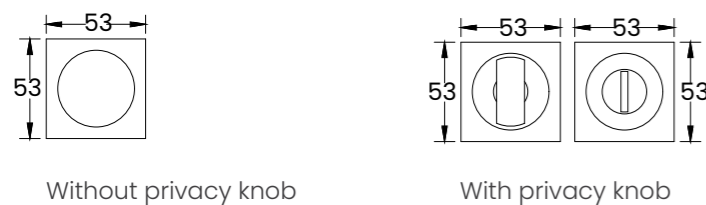

WALL PROFILE FOR AIR REDUCTION

It is possible to install a 20 x 10 mm section profile on the wall to reduce the air between the door and the wall.

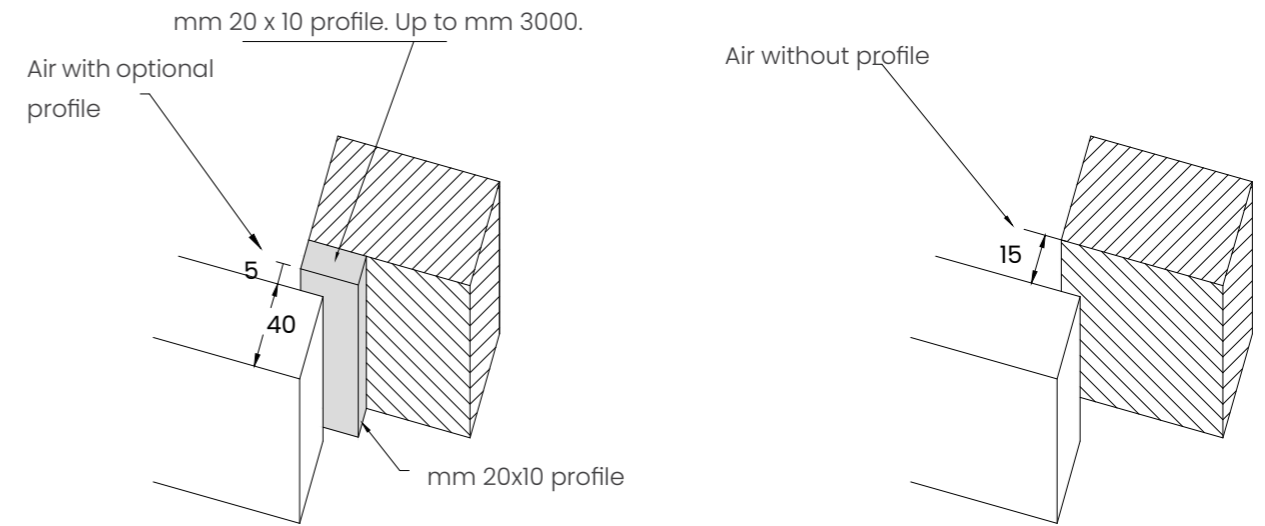

VERTICAL SIDE JAMB

Optional vertical side jamb sized mm 55 x 40, mandatory for matching the hook lock.

Optional side jamb includes a closing striker of mm 10 x 10 added on the door's profile.

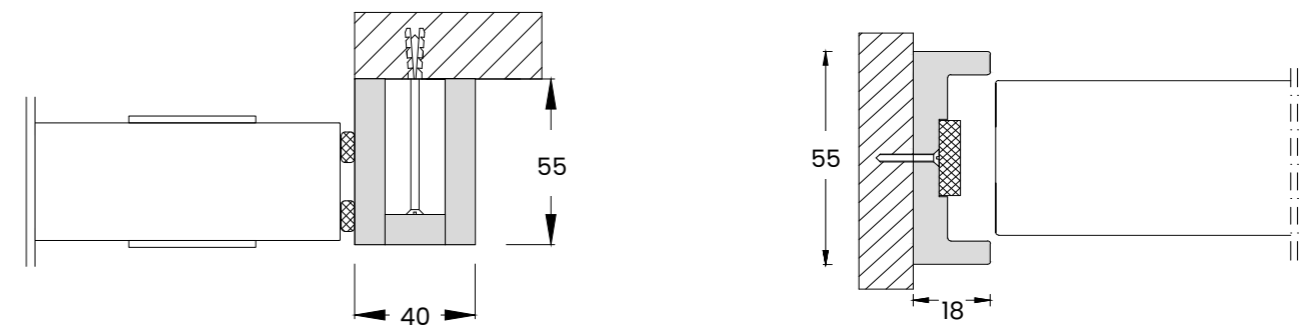

Both the side jamb and the central joint profile are made of extruded aluminum coordinated with the door.

This profile allows you to avoid the light between the door's panels.

Data sheets

Coplanar sliding Segreta-S door

The system remains perfectly flush with the wall on the external side while, on the internal side, the covering valance and the aluminum trolley covers remain visible. Also visible from the internal side is the particular door guide in the lower part; this is to guarantee correct functioning and a certain ease of intervention for any future maintenance of the product.

Given the aesthetic characteristics of formal cleanliness of the external side and the technical characteristics visible from the internal side, we recommend using the Segreta-S coplanar sliding door to close those compartments where aesthetic formality is necessary on only one side such as, for example, the closing a pantry or wardrobe compartment.

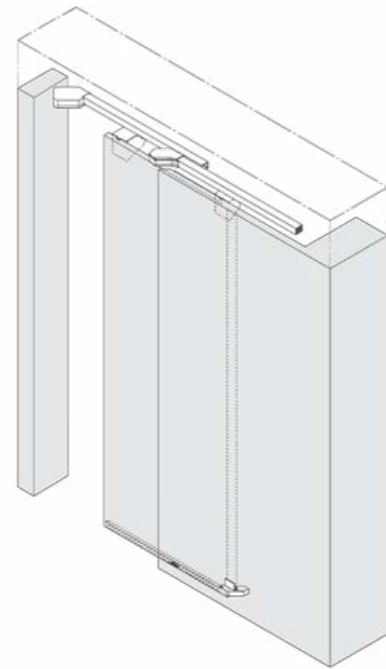

SKIRTING BOARD DETAIL



door opening's operating video **Segreta-S**

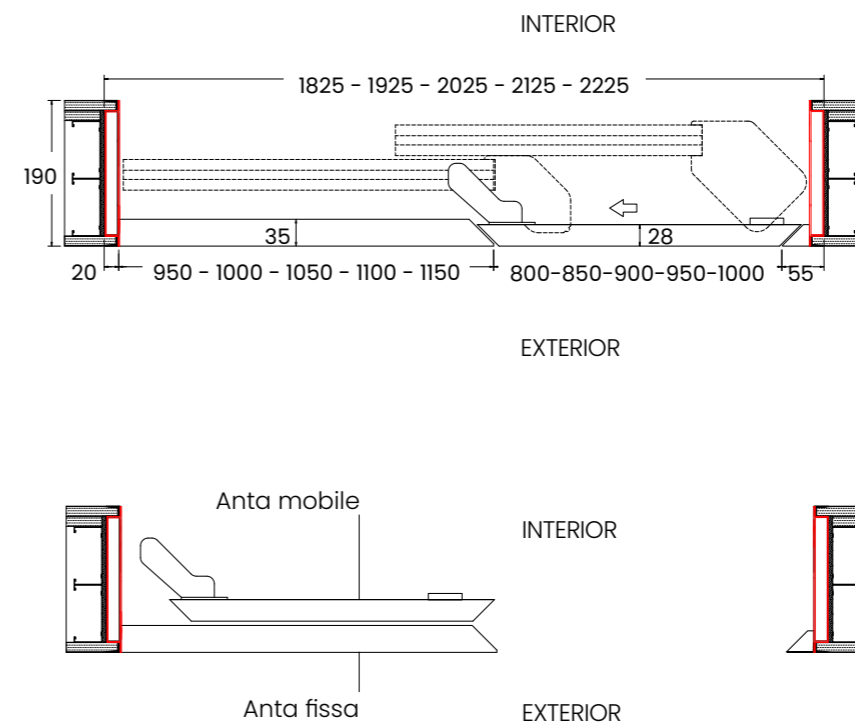
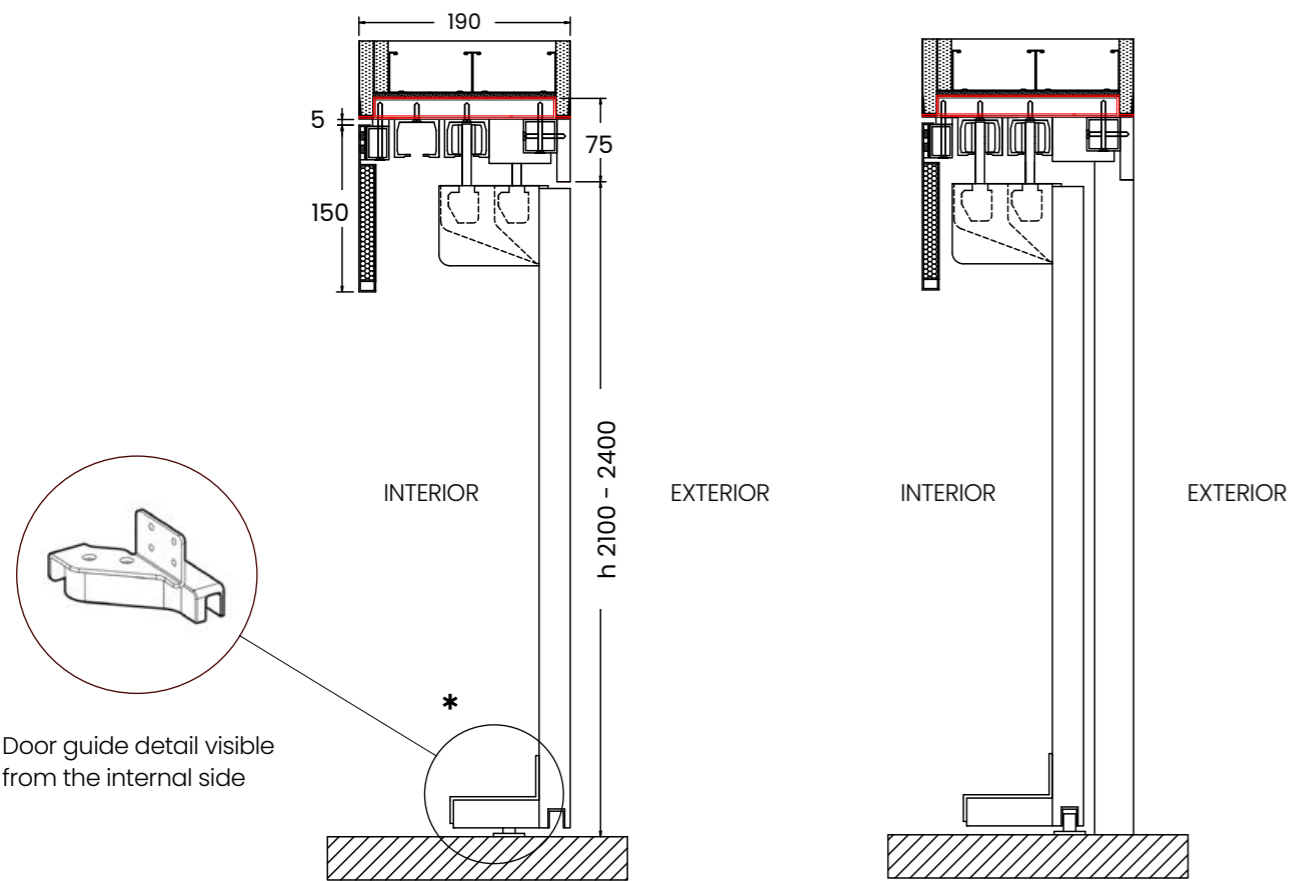

Sliding closure composed of a fixed panel and an opening panel made of reinforced honeycomb covered in MDF.

Perimeter frame in extruded aluminum to be finished flush with the wall, two-way sliding system, adjustable trolleys, movable internal valance and particular adjustable door guide visible from the internal side.

Data sheets

Versus System

2 PANELS SLIDING VERSUS CLOSET

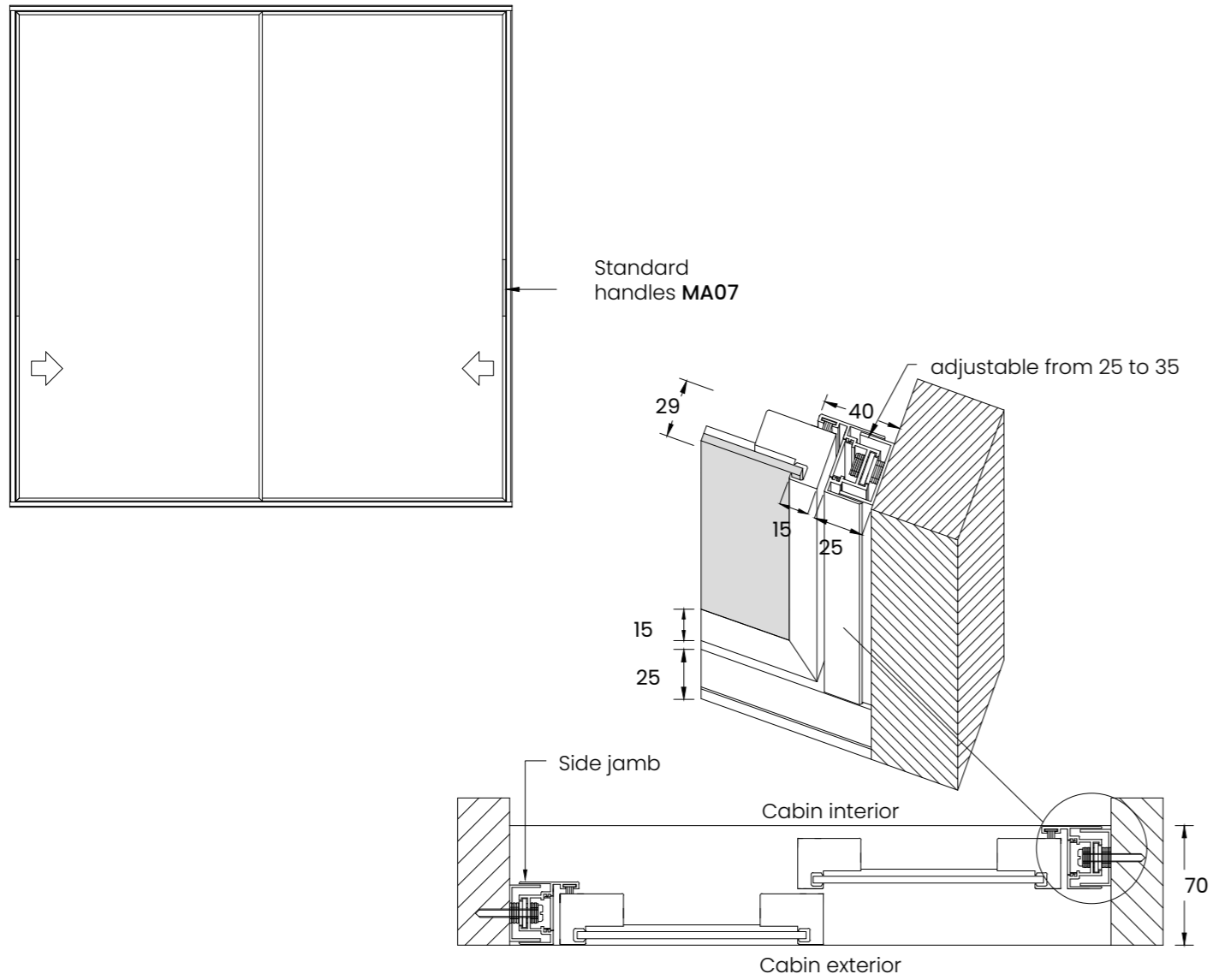

3 PANELS SLIDING VERSUS CLOSET

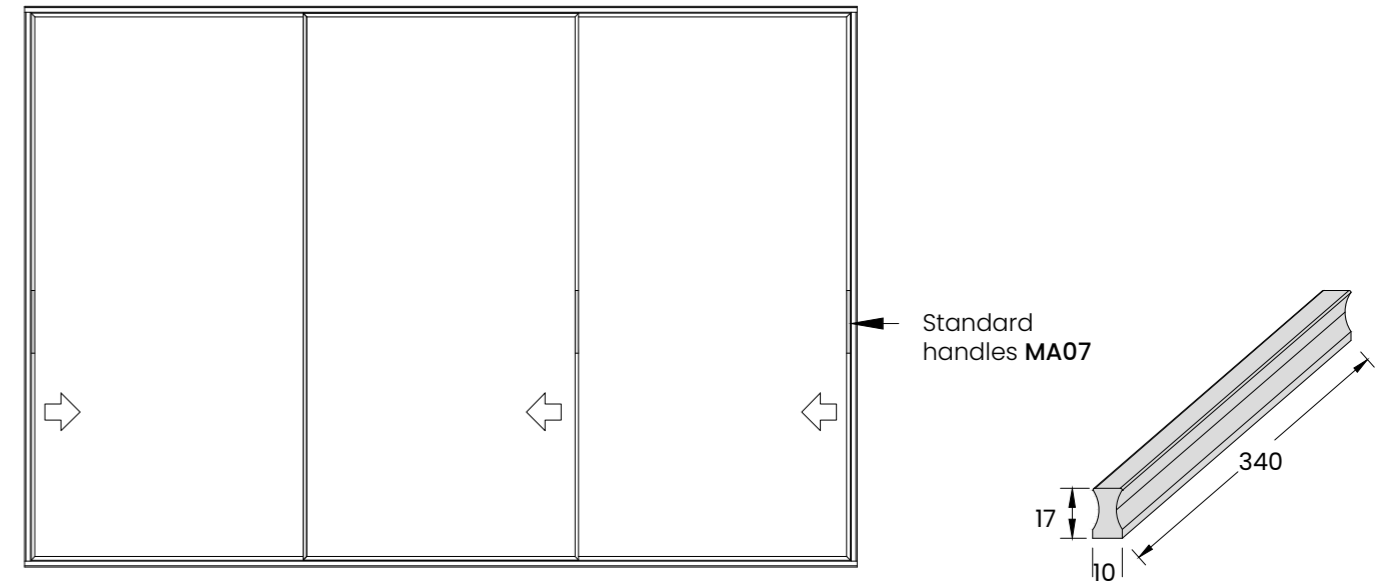

4 PANELS SLIDING VERSUS CLOSET

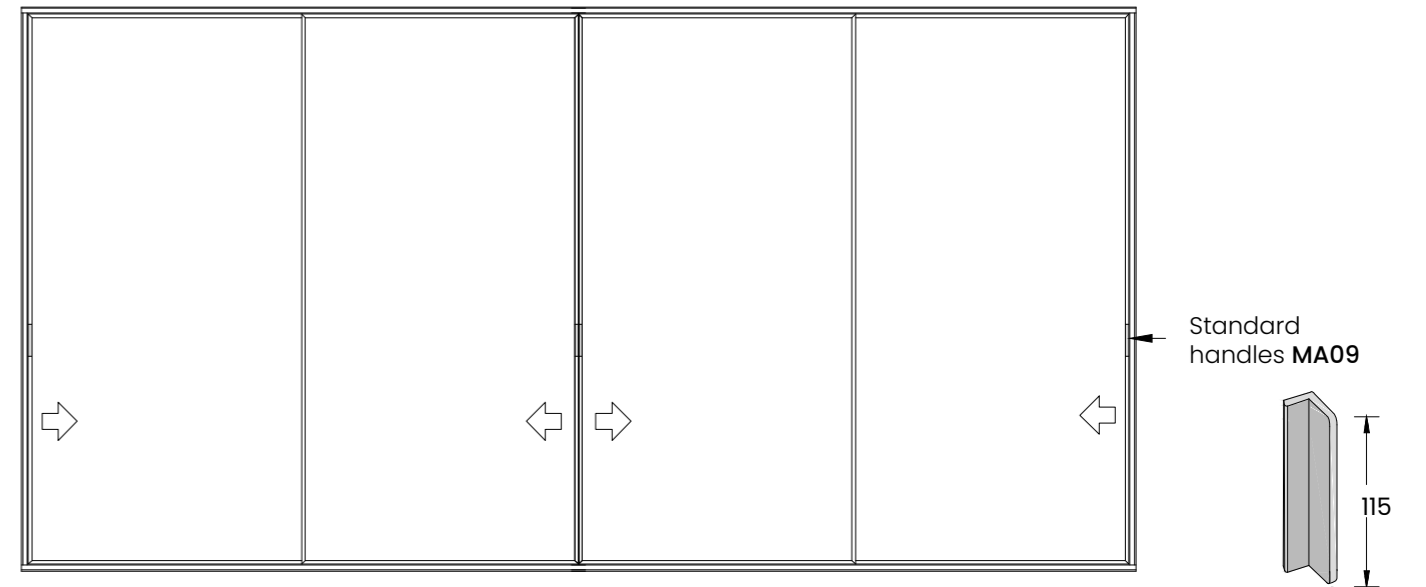

Digitally printed decorations

DS decorations digitally printed

It is possible to print images provided by the customer, subject to verification by our technical office



Extra Light sliding door | satin silver profile PA01 | extra-white satin glass with DS01 decoration | handle MA04



DS01

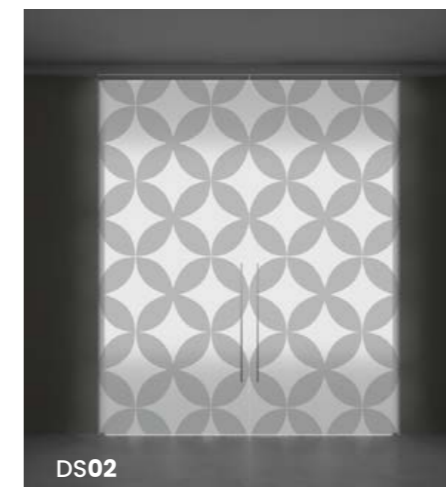

DS02



DS03



DS04



DS05



DS06



DS13

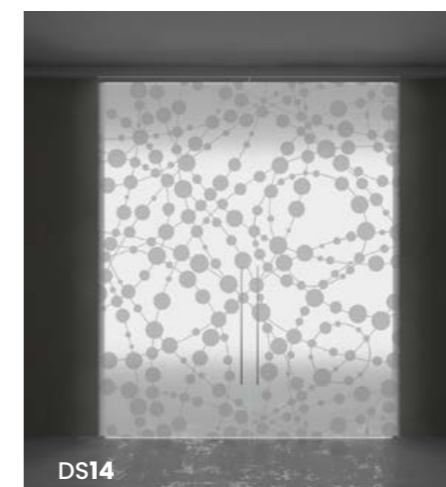

DS14



DS15



DS16

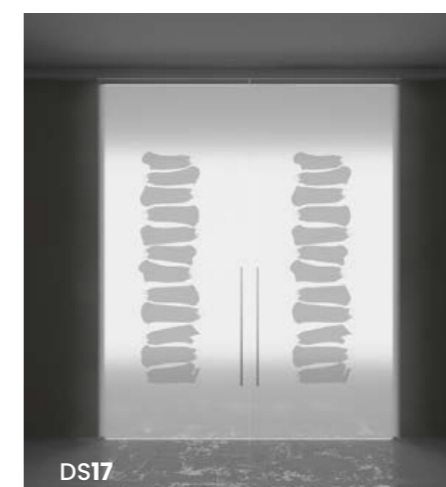

DS17



DS18



DS07



DS08



DS09

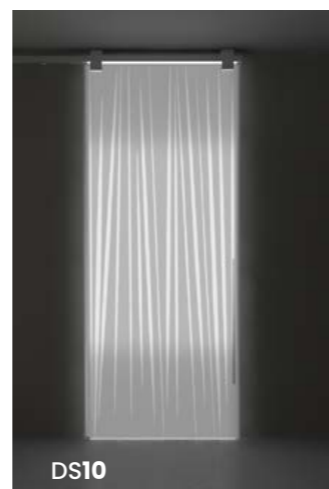

DS10



DSC11



DSC12



DSC13



DSC14



DS11



DS12



DSC01



DSC02



DSC15



DSC16



DSC17



DSC18



DSC03

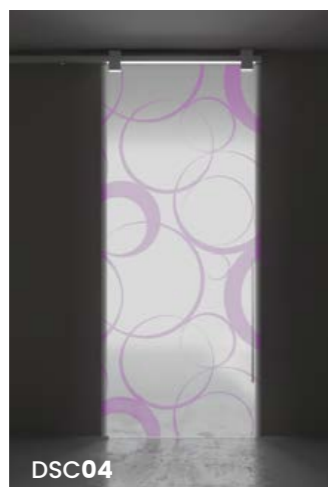

DSC04



DSC05



DSC06



DSC19



DSC20

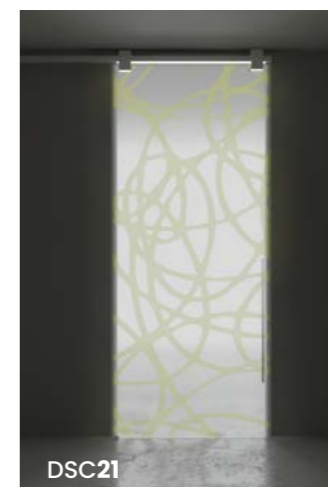

DSC21



DSC22

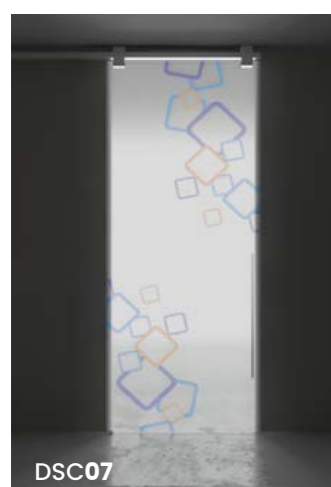

DSC07



DSC08



DSC09



DSC10



DSC23



DSC24

To create sample decorations it is necessary to send an image of adequate size (minimum definition 300dpi - 2Mb)

For clarifications on sample decorations, contact the sales office: commerciale@stainoestaino.it

Decorations for lacquered glass

DS decorations digitally printed (covered)

It is possible to print images provided by the customer, subject to verification by our technical office



Master sliding door | satin silver profile PA01 | glass with custom DV decoration | handle MA03

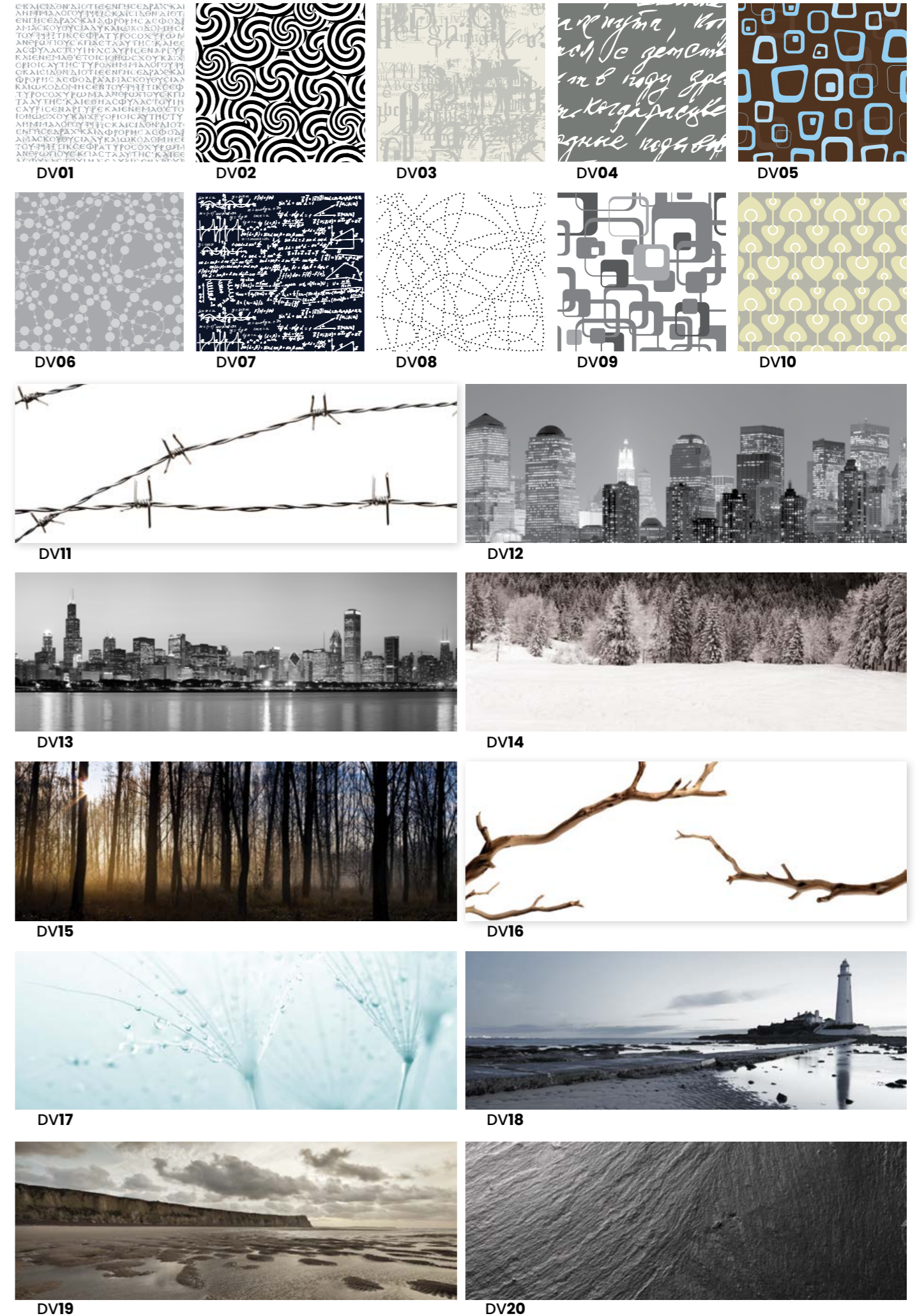

Finishings

Aluminum profiles
& crystals

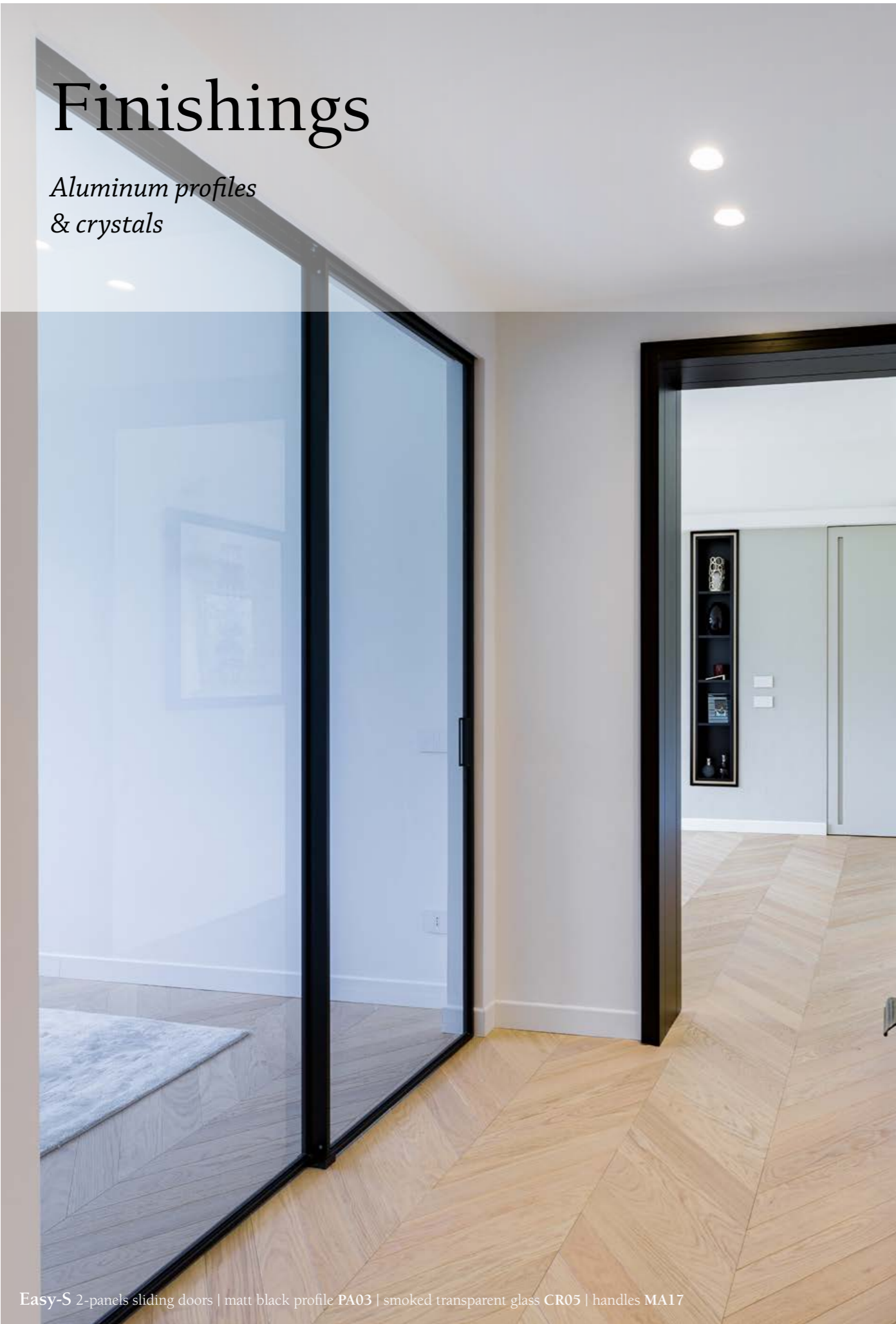

Easy-S 2-panels sliding doors | matt black profile PA03 | smoked transparent glass CR05 | handles MA17



PA01
Satin silver



PA05
Bronze



PA11
Dark bronze new

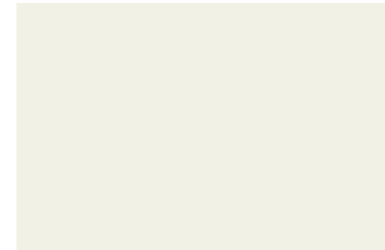

PA02
Matt white



PA07
White oak



PA13
Sandblasted iron grey

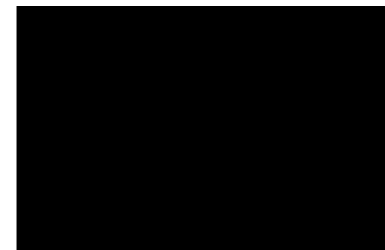

PA03
Matt black



PA09
Corten

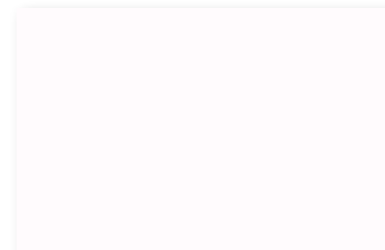

CR01
Transparent



CR05
Smoked transparent

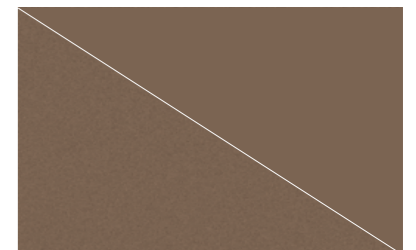

CR08 **CR09**
Etched bronze Transparent bronze

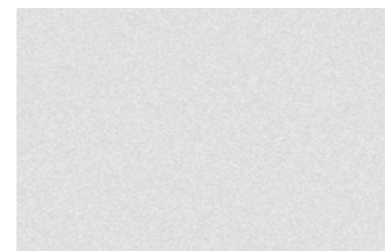

CR02
Acidato

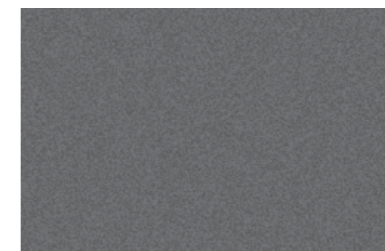

CR06
Etched smoked glass



CR10
Reflective smoked glass

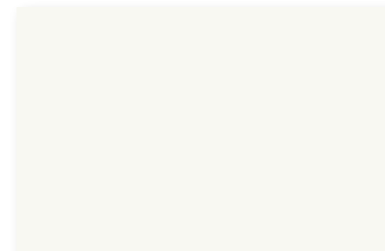

CR03
Milky white

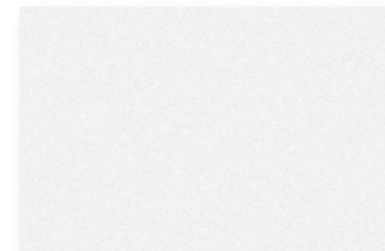

CR07
Etched extra-clear

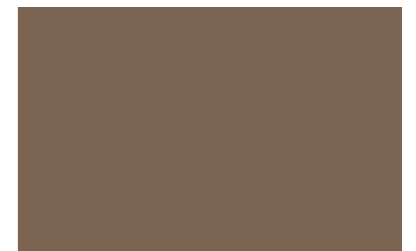

CR11
Bronze reflective glass

Finishings

*Lacquered crystals
and mirrors*



Master sliding door | profile and casing satin silver PA01 | matt lacquered glass CR08 | handles MA03



CL01
Bordeaux

CL02
Orange



CL12
Satin extra-clear white

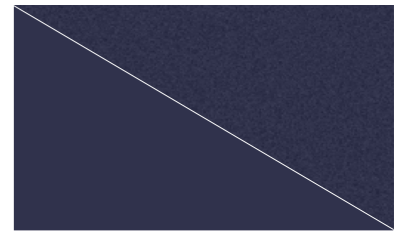

CL22
J.P.Blue

CL23
Satin J.P.Blue



CL03
Extra-clear white

CL04
Black

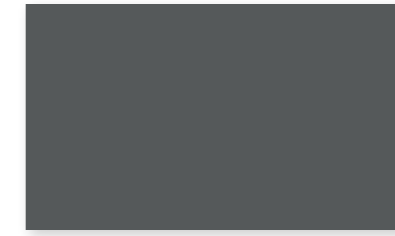

CL13
British grey 7011

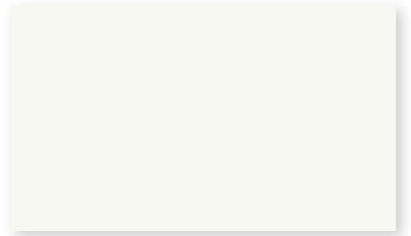

SP01
Normal



CL05
Antracite

CL06
Silver

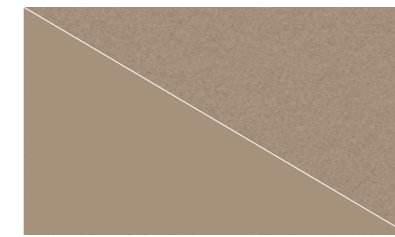

CL14
Cappuccino
1019

CL15
Cappuccino 1019
satin



SP02
Bronze

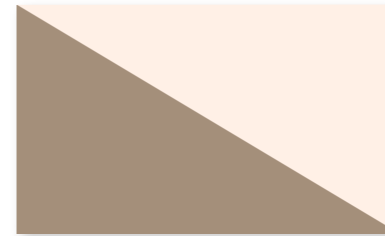

CL07
Beige

CL08
Pink grey 2005

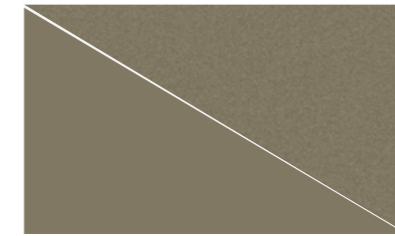

CR16
Green Army
7002

CL17
Green Army
7002 satin



SP03
Smoked



CL09
Metropoli black

CL10
Nervuré balck



CR18
Miami Green
6027

CL19
Miami Green 6027
satin



SP05
Nervuré sating silver

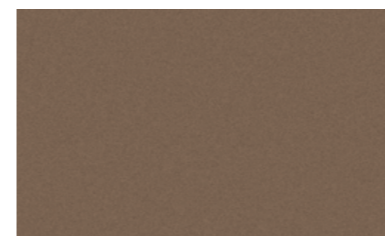

CL11
Metallized bronze

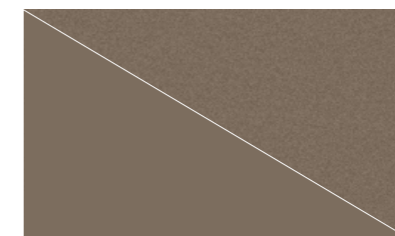

CL20
Visone 7006

CL21
Visone satin7006

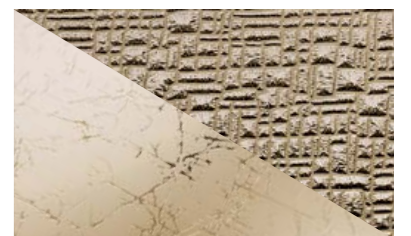

SP06
Nervuré satin
bronze

SP08
Metropoli satin
bronze

Finishings

Wood essences



Master door | satin silver profile PA01 | wood essence finishing EL06



EL01
Natural Oak

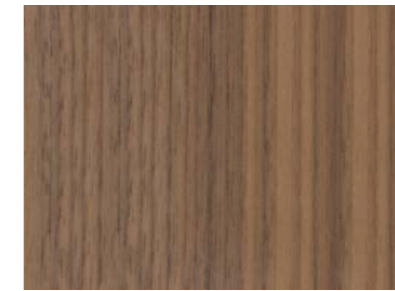

EL05
Natural Canaletto Walnut



EL08
Natural Mahogany



EL03
Natural Oak/dry saw-cut effect



EL06
Natural Canaletto Walnut saw-cut effect



EL07
Natural Mahogany/dry saw-cut effect



EL11
Whitened Oak



EL10
Natural Canaletto Walnut/dry saw-cut effect



RAL
Wood essence of choice*

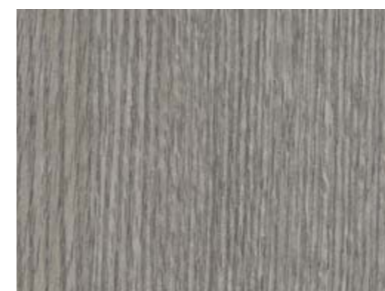

EL12
Grey Oak

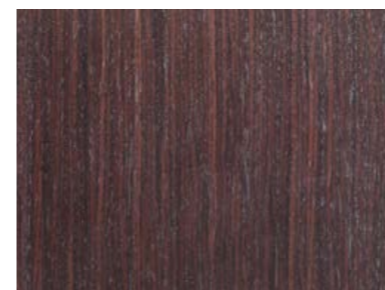

EL13
Dark Oak

* available finish sample

Online catalogue

download it on our website www.stainoestaino.it



Doors

Hinged and pivot doors

 Download the Catalogue



Sliding Doors

Sliding doors and systems

 Download the Catalogue



Segreta

Invisible flush-to-the-wall doors

 Download the Catalogue



Easy-S

Sliding and pivot doors with thin section profile

 Download the Scheda tecnica

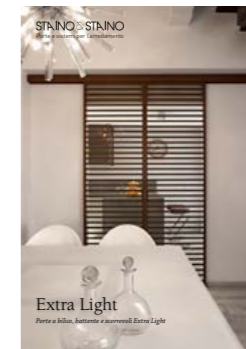

Extra Light

Minimal hinged, pivot and sliding doors

 Download the Scheda tecnica



iDoor®

Flush-to-the-wall door with rounded edges

 Download the Scheda tecnica



Master

Glass lacquered doors

 Download the Scheda tecnica



Revolution®

Continuous casing doors

 Download the Scheda tecnica



Glass

All-glass doors

 Download the Scheda tecnica

Staino&Staino srl | Via Danubio, 21/23/25 59100 Prato - Italy | Tel +39 0574 69 39 38 | Fax +39 0574 69 43 55 | www.stainoestaino.it
amministrazione@stainoestaino.it commerciale@stainoestaino.it export@stainoestaino.it

STAINO & STAINO Srl is not responsible for any inaccuracies contained in this catalog due to printing errors or for any other reason. STAINO & STAINO reserves the right to make changes to improve the products without notice. The prohibited reproduction without authorization, even partial, of the texts and images contained in this catalog is strictly prohibited by law.